

RVS-DX

Digital Soft Starter with internal ByPass
8-170A, 220-690V



Instruction Manual

Ver. 07/24



RVS-DX Instruction Manual

1. TABLE OF CONTENT

1.	Table of content	2
2.	Safety & Warnings	4
2.1	Safety	4
2.2	Attention.....	4
2.3	Warnings.....	4
3.	Technical Data	5
3.1	Introduction	5
3.2	Rating and frames sizes.....	5
3.3	Starter Selection	5
3.3.1	Motor current & Starting Conditions	5
3.3.2	Mains Voltage (line to line)	6
3.3.3	Control Voltage.....	6
3.3.4	Other Options	6
3.3.5	Starter selection tables for various voltage ratings.....	6
3.3.5.1	Starter selection for 230V, 400V, 480V, 600V	6
3.3.6	Ordering Information.....	7
4.	Recommended Wiring Scheme	8
4.1	Typical wiring diagram	8
4.2	Power wiring scheme for "Inside-Delta" Connection	9
4.3	Wiring Notes	9
4.3.1	Short Circuit Protection.....	10
4.3.2	Transient Protection.....	10
4.3.3	Control Supply (Terminals A1, A2).....	10
4.3.4	Start/Stop (or 4.3.4momentary start) Input (terminal B1).....	10
4.3.5	Aux. Input (terminal C1).....	11
4.3.6	Auxiliary output relay (terminals 13, 14).....	11
4.3.7	Fault Contact (terminals 23, 24).....	11
4.3.8	Options description	11
4.3.8.1	Analogue I/O (option # 5) (terminals T1, T2, Gnd, Out (-), Out (+))	11
4.3.8.2	RS-485 Communication (option # 3M) (terminals out(-),Out(+))	12
4.3.9	"Inside-Delta" mode	12
4.3.9.1	General information	12
4.3.9.2	Notes on "Inside Delta" connection	13
5.	Dimensions	14
6.	Installation	18
6.1	Prior to Installation	18
6.2	Mounting.....	18
6.3	Temperature range & heat dissipation	18
6.3.1	Calculating the enclosure size, for non-ventilated metallic enclosure.....	18
6.3.2	Additional Ventilation	19
6.3.3	UL, cUL Installation Instructions	19
7.	Control Keypad	20
7.1	LCD Arrangement	20
7.2	Push-buttons.....	20
7.3	Status LEDs.....	21
7.4	Reviewing and Modifying Parameters	21
7.5	Special Actions Performed in TEST/MAINTENANCE Mode.....	21
7.5.1	Run Self Test.....	21
7.5.2	View Software Version.....	21

7.5.3	Obtain Default Parameters	22
7.5.4	Reset Statistical Data	22
7.5.5	Calibrate Voltage, Current and (Factory Use Only!)	23
7.6	Mode Pages.....	23
7.6.1	Overview of All Mode Pages and Factory Defaults	24
7.6.2	Display Mode – page 0.....	27
7.6.3	Main Parameters – page 1.....	28
7.6.3.1	Tripping Curves of the Integrated Overload Protection.....	31
7.6.4	Start Parameters – page 2.....	32
7.6.4.1	Soft start parameters	35
7.6.5	Stop Parameters – page 3.....	36
7.6.5.1	Soft stop parameters.....	36
7.6.6	Dual Adjustment Parameters – page 4	38
7.6.7	Special features Parameters – page 5.....	39
7.6.7.1	WIDER SETTINGS Parameters:.....	40
7.6.8	Fault Parameters – page 6	41
7.6.9	I/O Programming Parameters – page 7	43
7.6.9.1	PROG. INPUT C1	44
7.6.10	Comm. Parameters – page 8- Applicable with Optional Modbus & DeviceNet Comm.....	45
7.6.11	Comm. Parameters – page 8 - Applicable with Optional Profibus Comm.....	46
7.6.12	Statistical Data – page 9.....	47
7.7	Non adjustable protection anf fault Resetting	47
7.7.1	Phase loss (and Under / Over Frequency).....	47
7.7.2	Phase Sequence	48
7.7.3	Shorted SCR or Wrong Connections	48
7.7.4	Heat-sink Over Temperature	48
7.7.5	External Fault	48
7.7.6	Fault and Reset	48
7.7.7	Auto Reset.....	48
7.8	Timing Occurrence Table	49
8.	STARTING PROCEDURE.....	50
8.1	Setting control voltage on-site RVS-DX8A-170A	50
8.2	Standard starting procedure.....	51
8.3	Examples of starting curves	52
8.3.1	Light Loads-Pumps, Fans, etc.	52
8.3.2	High Inertia Loads – Fans, Centrifuges, etc.....	52
8.3.3	Special starting – Using Dual Adjustment.....	53
8.3.3.1	Typical wiring diagram whit line contactor	53
8.3.3.2	Special starting – Using Dual Adjustment – wiring scheme.....	54
8.3.4	Choosing a suitable Pump Curve (centrifugal Pumps)	54
8.3.4.1	Starting Curve.....	54
8.3.4.2	Stopping Curve	55
8.3.4.3	Final torque during soft-stopping a pump motor	55
9.	TROUBLE SHOOTING	57
9.1	Blank RMA Form.....	60
10.	TECHNICAL SPECIFICATIONS:	61
11.	Appendix UL	63

2. SAFETY & WARNINGS

2.1 Safety

	1	Read this manual carefully before operating the equipment and follow its instructions.
	2	Installation, operation and maintenance should be in strict accordance with this manual, national codes and good practice.
	3	Installation or operation not performed in strict accordance with these instructions will void manufacturer's warranty.
	4	Disconnect all power inputs before servicing the soft-starter and/or the motor.
	5	After installation, check and verify that no parts (bolts, washers, etc) have fallen into the starter.
	6	During shipping, the soft-starter might have been roughly handled, therefore, it is recommended to initialize the soft-starter by connecting supply voltage prior to operating the soft-starter with a motor

2.2 Attention

	1	This product was designed for compliance with IEC 947-4-2 for class A equipment.
	2	RVS-DX 8 - 170 are UL and cUL approved. RVS-DX 210 - 1100 are designed to meet UL and cUL requirements.
	3	Use of the product in domestic environments may cause radio interference, in which case, the user may be required to employ additional mitigation methods.
	4	Utilization category is AC-53a or AC53b, Form 1. For further information, see Technical Specification

2.3 Warnings

	1	Internal components and PCBs are at mains potential when the RVS-DX is connected to mains. This voltage is extremely dangerous and will cause death or severe injury if contacted.
	2	When RVS-DX is connected to mains, even if control voltage is disconnected and motor is stopped, full voltage may appear on starter's output and motor's terminals.
	3	The starter must be grounded to ensure correct operation, safety and to prevent damage.
	4	Check that Power Factor capacitors and overvoltage devices are not connected to the output side of the soft starter. If PF capacitors are used, they must be connected on the line side of the RVS-DX . If a main contactor is used in combination with RVS-DX, the capacitors must be disconnected from RVS-DX when contactor is open.
	5	Do not interchange line and load connections

The company reserves the right to make any improvements or modifications to its products without prior notice.

3. TECHNICAL DATA

3.1 Introduction

The RVS-DX is a third generation, highly sophisticated and reliable starter designed for use with standard three-phase, three-wire, squirrel cage, induction motors.

It provides the best method of reducing current and torque during motor starting.

The RVS-DX starts the motor by supplying a slowly increasing voltage, providing soft start and smooth acceleration, while drawing the minimum current necessary to start the motor.

The RVS-DX is equipped with internal by-pass controlled by its micro-controller. The by-pass closes after the end of the starting process, thus reducing heating and saving power.

3.2 Rating and frames sizes

Starter type	Starter FLC [A]	Frame Size	Dimensions WxHxD [mm]	Weight [Kg]
RVS-DX 8	8	D1	120x232x122	3.0
RVS-DX 17	17	D1	120x232x122	3.0
RVS-DX 31	31	D1	120x232x122	3.0
RVS-DX 44	44	D1	120x232x122	3.0
RVS-DX 58	58	D2	129x275x182	5.2
RVS-DX 72	72	D2	129x275x182	5.2
RVS-DX 85	85	D3	129x380x182	8.5
RVS-DX 105	105	D3	129x380x182	8.5
RVS-DX 145	145	D4	172x380x192	12.5
RVS-DX 170	170	D4	172x380x192	12.5
Obsolete Consult Factory				
RVS-DX 210	210	D5	380x455x295	30.2
RVS-DX 310	310	D5	380x455x295	30.2
RVS-DX 390	390	D6	350x550x310	55
RVS-DX 460	460	D7	460x600x319	65
RVS-DX 580	580	D8	460x643x319	75
RVS-DX 650	650	D8	460x643x318	80
RVS-DX 820	820	D8	460x643x318	90
RVS-DX 950	950	D9	560x833x334	100
RVS-DX 1100	1100	D9	560x833x334	100

Notes:

Refer to section 5 on page 14 for detailed dimensions.

3.3 Starter Selection

The starter should be selected in accordance with the following criteria:

3.3.1 Motor current & Starting Conditions

Select the starter according to motor's Full Load Ampere (FLA) - as indicated on its nameplate (even if the motor will not be fully loaded).

The RVS-DX is designed to operate under the following maximum conditions:

Ambient Temperature [°C]	Starting Current [A]	Acceleration Time [sec]
40	300% \times In	30
	350% \times In	20
	400% \times In	5

Max. Starts per Hour: four (4) starts per hour at maximum ratings and up to 10 starts per hour at light load applications (consult factory).

Note:

For very frequent starts (inching applications) the inching current should be considered as the Full Load Current (FLC) (consult factory).

3.3.2 Mains Voltage (line to line)

Four Main Voltage levels are available: 400V, 480V, 600V and 690V (690V only available for RVS-DX 390A and up).

Note:

400V applies for 230 to 400V.

3.3.3 Control Voltage

The Control Voltage (terminals A1(N) – A2 (~) operates the electronic circuitry and the bypass.

Two voltage levels are available, selectable by internal jumper:

230VAC + 10%-15%, 50/60 Hz (standard)

115VAC+ 10%-15%, 50/60 Hz

Refer to section 8.1 on page 50 for instructions on setting control voltages on site.

3.3.4 Other Options

More options are available for the RVS-DX. (Refer to section 3.3.6 on page 7.):

Communication, Analog card, harsh environment treatment, , Remote panel,UL & cUL approval .

3.3.5 Starter selection tables for various voltage ratings.

1	The starter selection table below concern standard, 1500r.p.m. 50Hz, three-phase motors.
2	These values are given for guidance and may vary according to motor manufacturer and depending on the number of poles.
3	It is the user's responsibility to make sure that motor's FLA will never exceed Starter's FLC.

3.3.5.1 Starter selection for 230V, 400V, 480V, 600V

Starter type	Starter FLC [A]	Motor kW @230V, starter "In-Line" [kW]	Motor kW @230V, starter "Inside Delta" [kW]	Motor kW @400V, starter "In-Line" [kW]	Motor kW @400V, starter "Inside Delta" [kW]	Motor kW @480V, starter "In-Line" [kW]	Motor kW @480V, starter "Inside Delta" [kW]	Motor kW @600V, starter "In-Line" [kW]	Motor kW @600V, starter "Inside Delta" [kW]
RVS-DX 8	8	1.5	3	3	6.5	4	8	5.5	9
RVS-DX 17	17	4	8	8	12.5	9	15	12.5	22
RVS-DX 31	31	8	15	15	25	18.5	30	25	40
RVS-DX 44	44	12.5	22	22	37	25	45	30	59
RVS-DX 58	58	15	30	25	51	37	59	45	80
RVS-DX 72	72	20	37	37	59	45	80	59	100
RVS-DX 85	85	25	40	45	80	55	90	59	110
RVS-DX 105	105	30	55	55	90	59	110	80	147
RVS-DX 145	145	40	75	75	132	90	160	110	200
RVS-DX 170	170	51	90	90	160	110	200	140	250
RVS-DX 210	210	59	110	110	184	140	220	160	295
RVS-DX 310	310	90	160	160	257	200	355	257	450
RVS-DX 390	390	110	200	200	355	257	475	315	560
RVS-DX 460	460	140	220	250	400	295	560	400	670
RVS-DX 580	580	180	315	315	560	400	670	500	
RVS-DX 650	650	c	c	c	c	c	c	c	c
RVS-DX 820	820	250	450	450	670	560		670	
RVS-DX 950	950	295	500	500		670		-	
RVS-DX 1100	1100	355	560	600				-	

Note:

C – Consult factory

3.3.6 **Ordering Information**

RVS-DX **31-** **400-** **230-** **0-** **S**
Full load Current **Mains Voltage** **Control Voltage** **Options** **Front Panel**

Full load Current	
Specify	Description
Starter's FLC [A]	8, 17, 31, 44, 58, 72, 85, 105, 145, 170

Mains Voltage	
Specify	Description
400	230-400VAC + 10%-15%, 50/60 Hz
480	480VAC + 10%-15%, 50/60 Hz
600	600VAC + 10%-15%, 50/60 Hz

Control Voltage	
Specify	Description
115	115VAC + 10%,-15%, 50/60 Hz
230	230VAC + 10%,-15%, 50/60 Hz
Notes:	<ul style="list-style-type: none"> Control voltage can be changed on site for RVS-DX up to 170A.

Options	
Specify	Description
0	No options
3M	Communication RS-485 (MODBUS) ⁽¹⁾
3P	Communication Profibus ⁽¹⁾
3D	Communication RS-485 (MODBUS) and external DeviceNet to Modbus Gateway ^{(1) (3)}
5	Analog card – Thermistor in and Analog out ⁽¹⁾
8	Harsh environment treatment
D	Remote panel mounting replacing the original panel.(supplied with 1.5 m cable) ⁽²⁾
U	UL & cUL approval
H	Special character set LCD display
RU	Russian display
Z or 2Z	Bazan - consult factory
Notes:	<ul style="list-style-type: none"> For more than one option indicate, for example: 8-5 (Harsh environment and Analog out) Options must be factory installed. ⁽¹⁾ From RVS-DX 8A and up to RVS-DX 44A - One option can be installed - either Modbus communication (3M) or Profibus communication (3P) or DeviceNet (3D) or Analog out (5). From RVS-DX 58A and up – In case one of the communication options (either 3M or 3P or 3D) is ordered, Analog out (option 5) <u>must</u> be ordered as one package and vice versa. ⁽²⁾ Remote keypad option available for RVS-DX 58A and up. ⁽³⁾ External DeviceNet to Modbus Gateway is supplied when DeviceNet communication link is ordered.

Front Panel	
Specify	Description
S	Standard

Example:

RVS-DX rated 170A, mains voltage- 230V, control voltage- 115V, Modbus communication card, Analog card, Harsh environment treatment and standard front panel:

RVS-DX 170 - 400 - 115 - 3M - 5 - 8 - S (note that 400V mains is for 230-400V)

4.2 Power wiring scheme for “Inside-Delta” Connection

(Refer to section 4.3.9 on page 12)

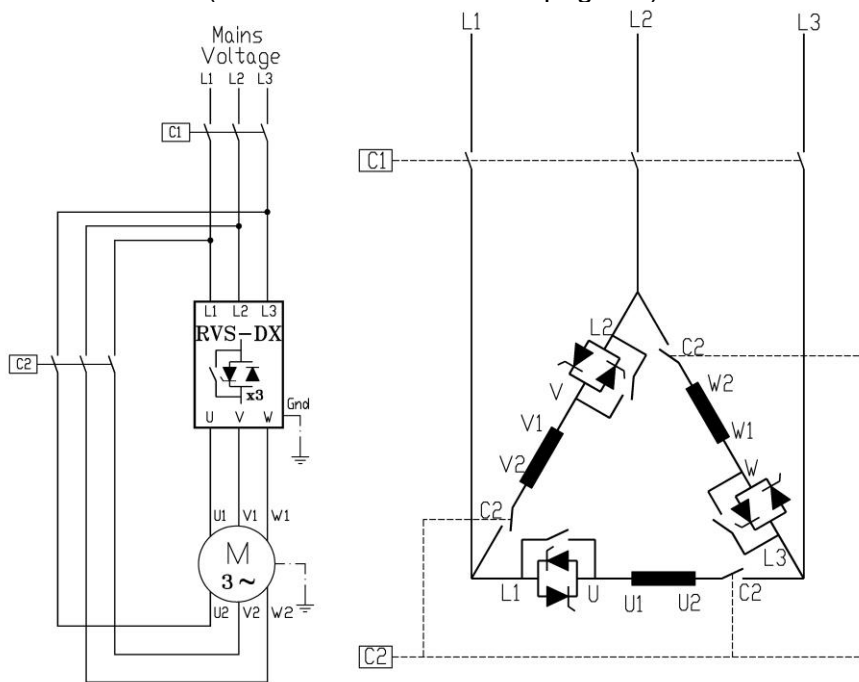

Connecting RVS-DX INSIDE DELTA

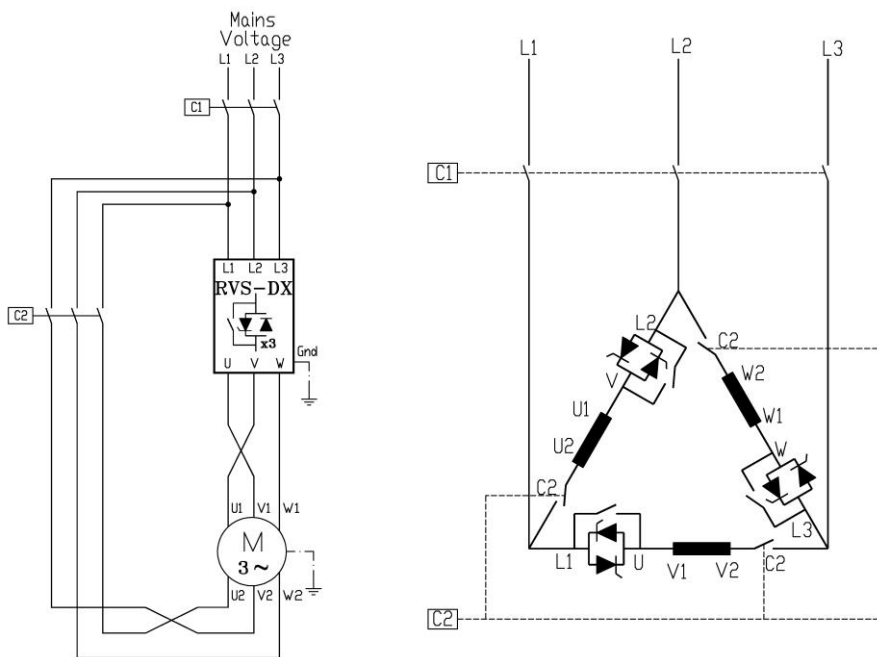

Reverse speed with RVS-DX connected INSIDE DELTA.

Notes:

When installing the RVS-DX INSIDE DELTA, it is highly recommended to use a line contactor (C1) or INSIDE DELTA contactor (C2) in order to avoid a destruction of the motor in case of a shorted SCR in the RVS-DX. If a contactor is connected Inside the Delta (C2) only, motor terminals are “live” (full voltage) even when contactor is open.

4.3 Wiring Notes

WARNINGS!	When mains voltage is connected to the RVS-DX, even if control voltage is disconnected, full voltage may appear on the starter load terminals. Therefore, for isolation purposes, it is necessary to connect an isolating device before the starter.
------------------	--

Power factor correction capacitors and overvoltage devices must not be installed on starters load side. When required, install capacitors or overvoltage devices on starter's line side.

4.3.1 Short Circuit Protection

For IEC class 2 coordination, protect the starter against a short circuit by thyristor Protection Fuses for I²t and fuses as in dictated in the following table:

RVS-DX	Max. thyristor I ² t [A ² Sec]	BUSSMAN		GEC ALSTOM		SIBA		FERRAZ – SHAWMUT (IEC Style 690/700V)	
		Rate [A]	P/N	Rate [A]	P/N	Rate [A]	P/N	Rate [A]	P/N
RVS – DX 8	400	30	FWP 30B	32	B210612			32	URD 000-32
RVS – DX 17	5,000	50	FWP 50B	63	B210615			63	6.6URD30D11A0063
RVS – DX 31	10,000	90	FWP 90B	100	V320063			100	6.6URD30D11A0100
RVS – DX 44	12,000	125	FWP 125A	100	X320063			100	6.6URD30D11A0100
RVS – DX 58	15,000	150	FWP 150A	125	X320065			125	6.6URD30D11A0125
RVS – DX 72	18,000	175	FWP 175A	160	B320069	200	SQB1-200	200	6.6URD30D11A0200
RVS – DX 85	40,000	200	FWP 200A	200	E320371	200	SQB1-200	200	6.6URD30D11A0200
RVS – DX 105	60,000	250	FWP 250A.	250	J320375	250	SQB1-250	250	6.6URD30D11A0250
RVS – DX 145	100,000	300	FWP 300A	315	M320079	315	SQB1-315	315	6.6URD30D11A0315
RVS – DX 170	140,000	400	FWP 400A	350	Y320480	350	SQB1-350	350	6.6URD30D11A0350
RVS – DX 210	200,000	500	FWP 500A	450	D320485	450	SQB1-450	450	6.6URD30D11A0450
RVS – DX 310	600,000	700	FWP 700A	630	H320489	630	SQB1-630	630	6.6URD31D11A0630
RVS – DX 390	700,000	700	FWP 700A	800	T320591	800	SQB1-800	800	6.6URD31D11A0800
RVS – DX 460	800,000	800	FWP 800A	900	V320592	900	SQB1-900	900	6.6URD32D11A0900
RVS – DX 580	1,200,000	1000	FWP 1000A	1000	W320593	900	SQB2-900	1000	6.6URD32D11A1000
RVS – DX 650	2,000,000	1200	FWP 1200A	2X 700	2X S320590	1100	SQB2-1100	1250	6.6URD33D11A1250
RVS – DX 820	2,000,000	1200	FWP 1200A	2X 700	2X S320590	1100	SQB2-1100	1250	6.6URD33D11A1250
RVS – DX 950	4,500,000	2X 1000	2X FWP 1000A	2X 900A	2X V320592		SQB2-1250	1600	6.6URD33D11A1600
RVS – DX 1100	4,500,000	2X 1000	2X FWP 1000A	2X 900A	2X V320592		SQB2-1250	1600	6.6URD33D11A1600

Notes:

1. The above table is for maximum starting current of 400% of FLC, maximum starting time of 5 sec and rated voltage up to 690V V.
2. Rating may change with different external conditions such as ambient temperature, forced cooling etc. Refer to fuse manufacturer catalogs to confirm correct values.
3. For UL, cUL short circuit protection, starter shall be protected by a circuit breaker. See also section 6.3.3 page 19.

4.3.2 Transient Protection

Line transient voltages can cause a malfunction of the starter and damage to the thyristors. All RVS-DX starters incorporate Metal Oxide Varistors (MOV) to protect from normal line voltage spikes.

When higher transients are expected, additional external protection should be used (consult factory).

4.3.3 Control Supply (Terminals A1, A2)

220-240V or 110-120V, 50/60Hz is required to power the electronic circuitry and the bypass. Factory set value is indicated on the starter's side label.

This voltage can be from a grounded or ungrounded mains system.

In models up to 310A, voltage level 110V /220V can be changed in the field. (Refer to section 8.1 on page 50)

4.3.4 Start/Stop (or 4.3.4momentary start) Input (terminal B1)

Input from a maintained contact. Close contact between A2 and B1 to soft start the motor.

To stop the motor open the contact.

If Deceleration time is set to a value other than 0 seconds the motor will soft stop.

If Deceleration time is set to 0 seconds the motor will stop immediately. (Refer to section 7.6.5 on page 36)

If Aux Input is set as Start / Stop, then terminal B1 is used as momentary N.O. Start input and input C1 is used as maintained N.C Stop input. (Refer to section 7.6.9 on page 43)

For emergency stop of the motor disconnect control voltage from A1, A2 terminals.

4.3.5 **Aux. Input (terminal C1)**

Input from a maintained contact, connected between terminals A2 and C1 to operate as programmed input.

Aux. Input can be programmed as one of six options:

- (1) Dual Adjust
- (2) Generator Function
- (3) Slow Speed / Reverse
- (4) External fault
- (5) Remote reset after fault has been removed.
- (6) Start / Stop (terminal C1 can be used as a maintained N.C Stop input and terminal B1 as momentary N.O. Start input – refer also to section 4.3.4 above.

For Aux. Input programming refer to section 7.6.9 on page 43.

4.3.6 **Auxiliary output relay (terminals 13, 14)**

Voltage free, N.O , 8A, 250VAC, 1800VA max.

The contact incorporates 0-60 seconds On & Off delays. The auxiliary output relay can be programmed to operate in two modes:

1. IMMEDIATE - Close its contact at start signal (after programmed “on delay” time has elapsed) and open its contact at the end of deceleration time (if any) (after programmed “off delay” time has elapsed).
2. END OF ACCEL. - Close its contact at end of soft start (after programmed “on delay” time has elapsed) and open its contact at the beginning of soft stop (if any) (after programmed “off delay” time has elapsed).

The relay contact will open also in case of a fault or upon control supply outage.

This output is generally used to:

- (1) Release the brake of a brake motor.
- (2) Interlocking with other systems.
- (3) Signalling.

For Aux. output programming refer to section 7.6.9 on page 43.

4.3.7 **Fault Contact (terminals 23, 24)**

Voltage free, N.O , 8A, 250VAC, 1800VA max.

The contact changes its position upon fault and returns to its original position after fault has been removed and starter was reset. When disconnection of Control Supply the contacts will be closed. Fault relay can function as a “Fault” relay or as a “Fail-Safe” relay.

For Fault relay programming refer to section 7.6.9 on page 43.

4.3.8 **Options description**

4.3.8.1 Analogue I/O (option # 5) (terminals T1, T2, Gnd, Out (-), Out (+))

The Analogue option incorporates two functions:

- Thermistor input
- Analogue output

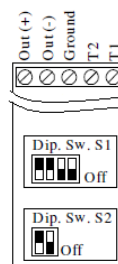

Analogue P.C.B. layout

Thermistor input (terminals T1, T2)

Programmable as PTC or NTC type thermistor. Trip value is adjustable between 1-10K, preset delay of 2 Sec.

For thermistor input programming refer to section 7.6.8 on page 41.

Ground Terminal (terminal Gnd)

Connect thermistor and / or Analogue output shield to this ground terminal.

Analogue Output (terminals Out (+), Out (-))

Dip switches allow selection between: 0-10VDC, 0-20mA, 4-20mA

Analogue value can be programmed via the key pad in I/O PROGRAMMING PARAMETERS page to one of the values as follows: (refer to section 7.6.9 on page 43.)

- A. 0...200% of FLA (Default setting)
- B. 0...200% of Pn
- C. Power factor (POWER FACTOR & POWER measurement only available in RVS-DX58A and up)

Dip No.	4-20 mA*	0-20 mA	0-10VDC
Dip-Sw. S1 # 1	On	On	Off
Dip-Sw. S1 # 2	On	On	Off
Dip-Sw. S1 # 3	Off	Off	On
Dip-Sw. S1 # 4	Off	Off	On
Dip-Sw. S2 # 1	On	Off	Off
Dip-Sw. S2 # 2	No use	No use	No use

* Default

Notes:

- It is important that the RVS-DX is properly grounded, and control module is tightly fastened to the power section.
- Use twisted shielded cable for thermistor connection.

4.3.8.2 RS-485 Communication (option # 3M) (terminals out(-), Out(+))

Standard RS485, Half Duplex with MODBUS Protocol, baud rate 1200, 2400, 4800, 9600 BPS.

Twisted shielded pair should be used, connect shield to ground a PLC/Computer side. Terminals (-) & (+) must be wired to control supply for operation in communication mode. Leave terminal NC not connected.

Note: When DeviceNet option is required an external device will be provided with the option.

This gateway is connected via 2 wires to the optional Modbus terminals.

Refer to section 7.6.10 on page 45.

4.3.9 "Inside-Delta" mode**4.3.9.1 General information**

When the RVS-DX is installed "Inside Delta", the individual phases of the Starter are connected in series with the individual motor windings (6 conductor connections as with the star-delta starter). The soft starter must only conduct about 67 % (=1\1.5) of the rated motor current. This ensures the use of a significantly smaller device.

For example:

For a motor with a rated current of 155A motor, a 170A starter will be selected to operate "In-Line".

For "Inside Delta" starter, we calculate (155 x 67% = 104A) and select a 105A starter.

Less heat dissipates in the cabinet vs. the standard "In-Line" connection.

4.3.9.2 Notes on “Inside Delta” connection

- “Inside Delta” requires 6-wire to the motor.
- Wrong motor connection will cause serious damage to the motor windings.
- When installing the RVS-DX “inside delta” it is highly recommended to use a contactor in series to the RVS-DX or upstream (after motor protection) in order to avoid a destruction of the motor in case of a shorted SCR in the RVS-DX.
- The sinusoidal shape of the current is imperfect (since each phase is separately fired and not influenced by other phase firing).
As a result, higher harmonic content is incurred (THD), which can be as high as twice the THD value as in the standard “In-Line”.
- Higher motor heating is expected for the same motor size (due to the higher THD).
- Phase sequence must be correct; otherwise, “Phase Sequence fault” will trip the starter immediately (without any damage).
- Higher torques can not be obtained
- Factory preset - features and functions when “Inside Delta” mode is configured:
 - No Pulse Start.
 - No curve selection (Curve 0 !! only).
 - No Slow Speed
 - No Phase sequence “Off” mode

Note :

For a high starting torque process, it is recommended to use the starter in the “In Line” connection.

WARNINGS!	Beware! Wrong connection of the starter or the Motor, will seriously damage the motor.
	When using “Inside delta” connection: 1. It is highly recommended to use a contactor in series to the RVS-DX or upstream (after motor protection) in order to avoid a destruction of the motor in case of a shorted SCR in the RVS-DX. 2. If Contactor is connected Inside the Delta, motor terminals are “live” (full voltage) even when contactor is open.

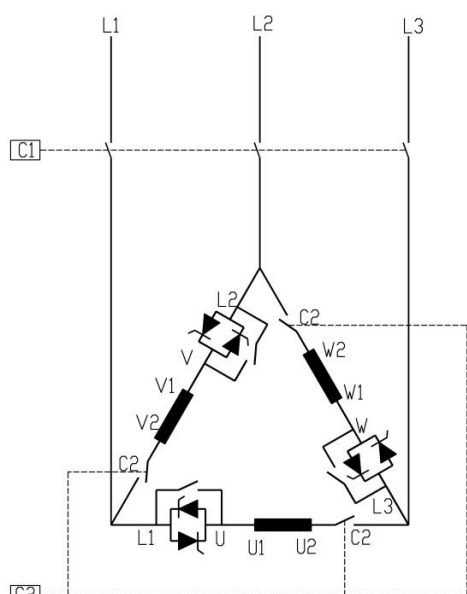

RVS-DX connected INSIDE DELTA

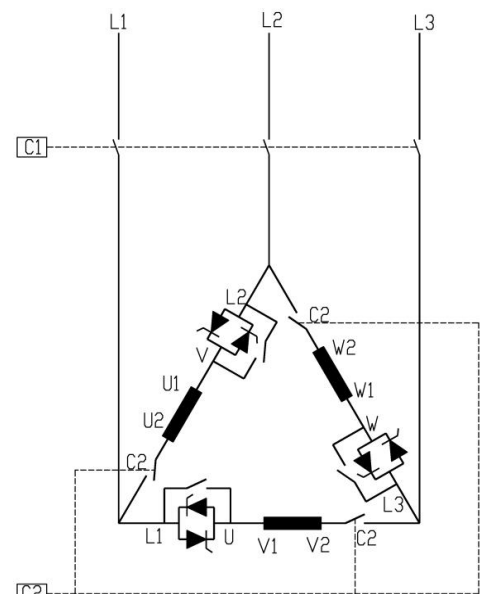

Speed reverse with RVS-DX connected INSIDE DELTA

- (1) C1 is a line contactor.
 - (2) C2 is an “Inside Delta” contactor.
 - (3) U1-U2, V1-V2, W1-W2 are motor’s windings.
 - (4) L1-U, L2-V, L3-W are RVS-DX controlled phases.
- Refer also to section 4.2 page 9.

5. DIMENSIONS

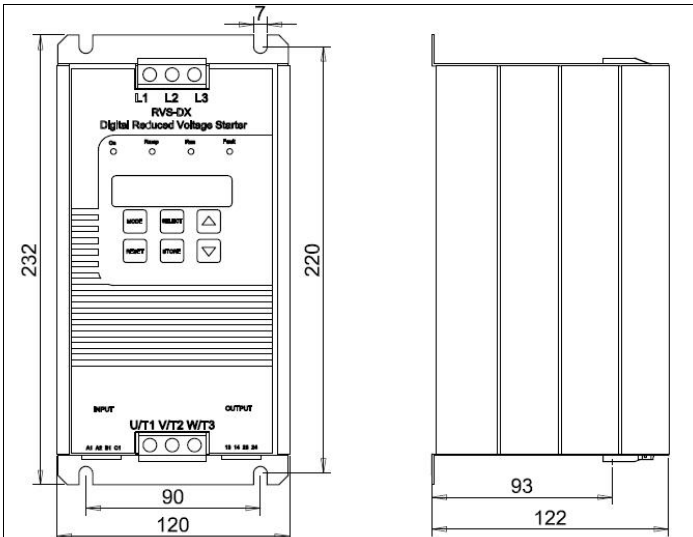

RVS-DX 8, 17, 31, 44

Note:

Mains voltage terminals: 16mm²

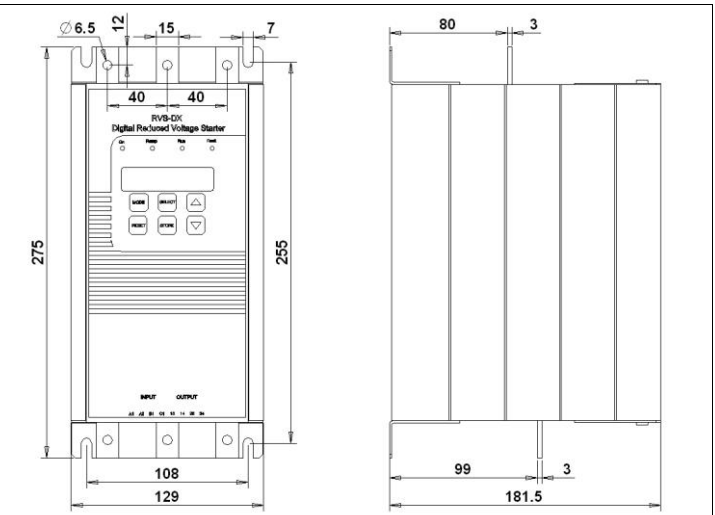

RVS-DX 58, 72

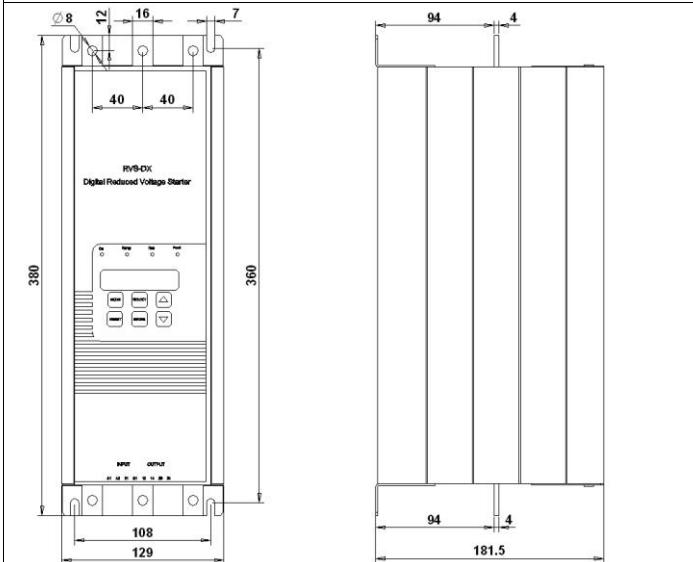

RVS-DX 85, 105

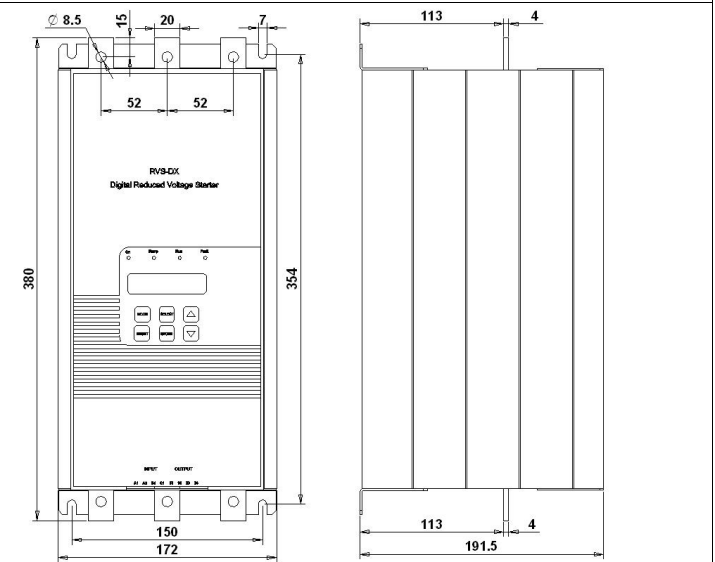

RVS-DX 145, 170

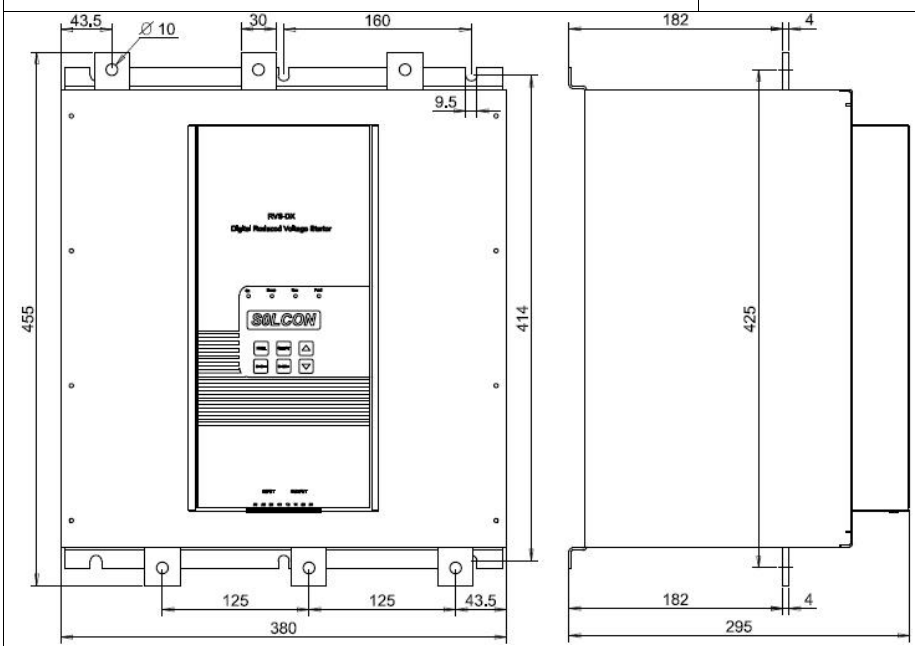

RVS-DX 210

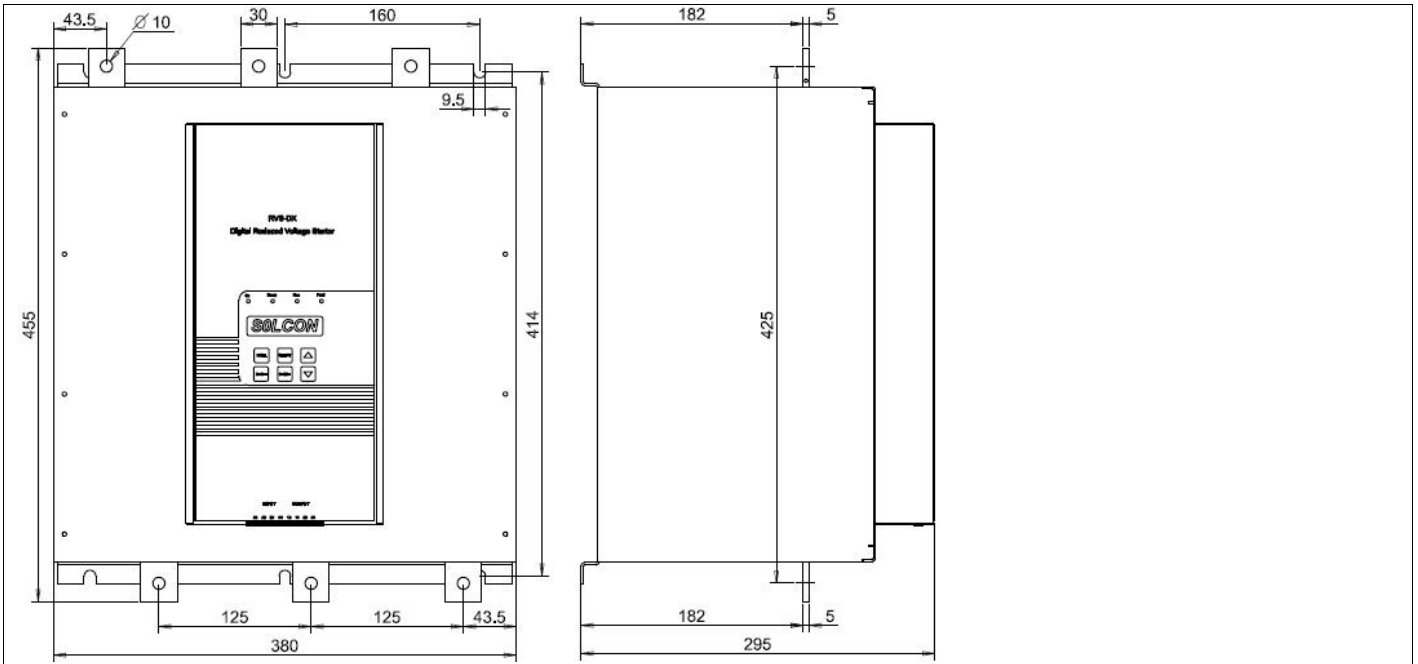

RVS-DX 310

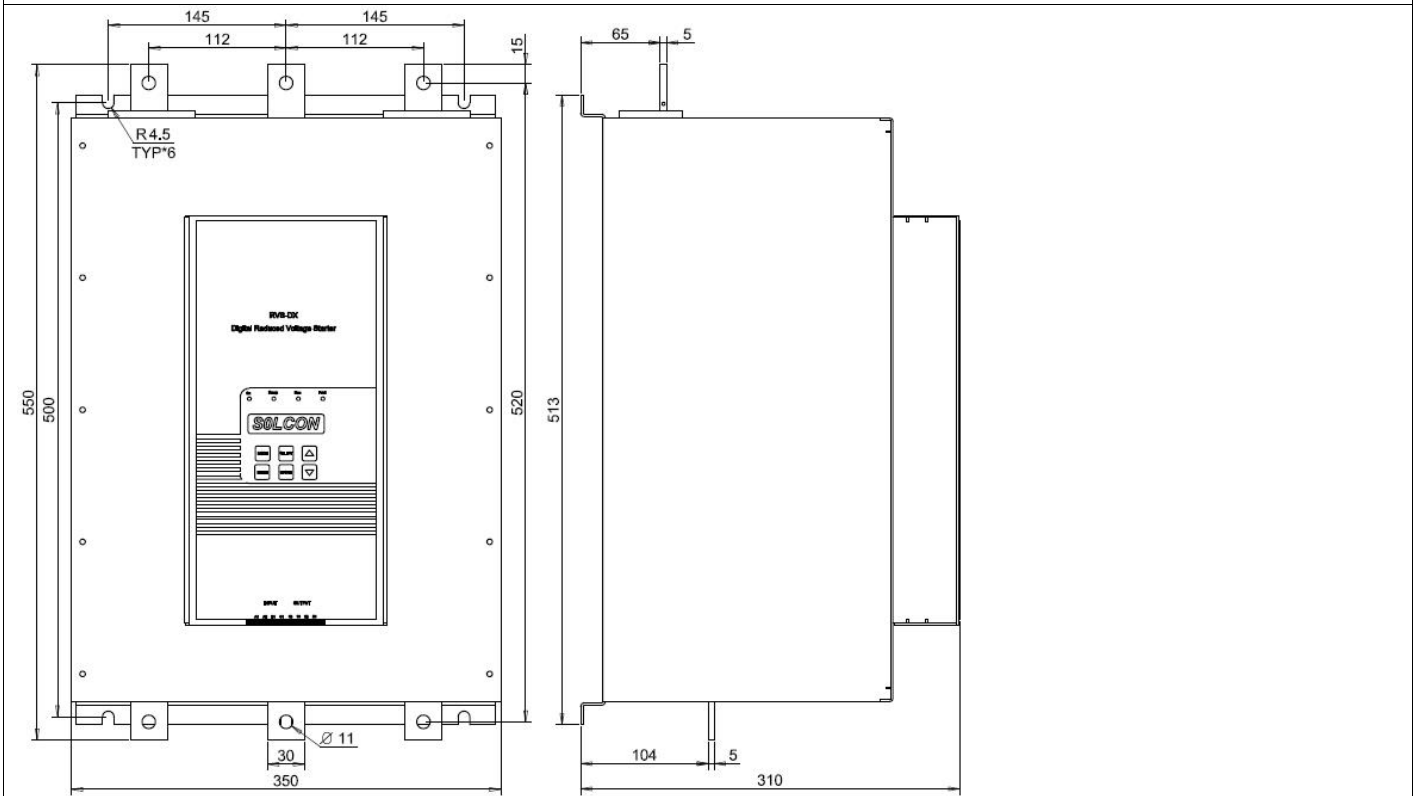

RVS-DX 390

16 • Dimensions

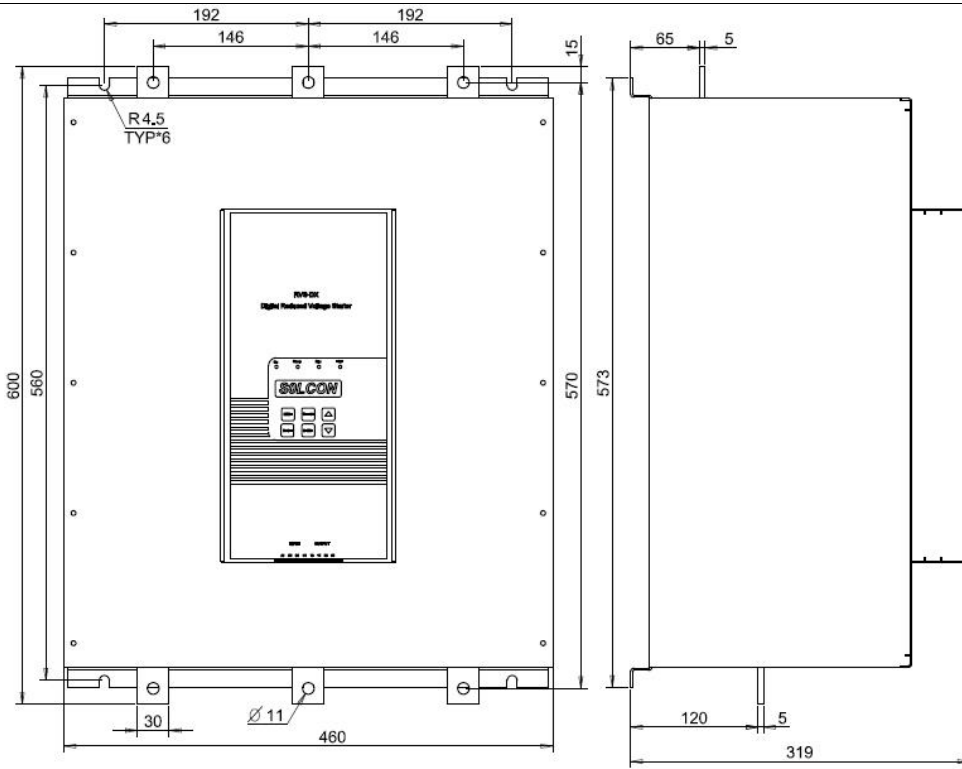

RVS-DX 460

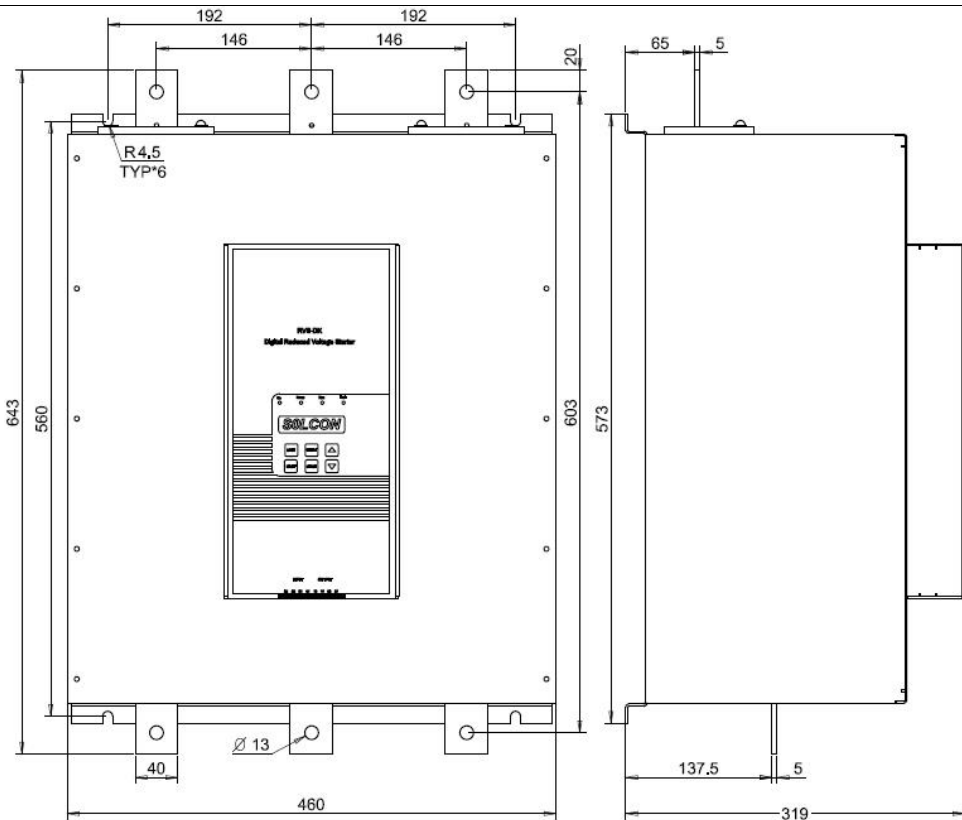

RVS-DX 580

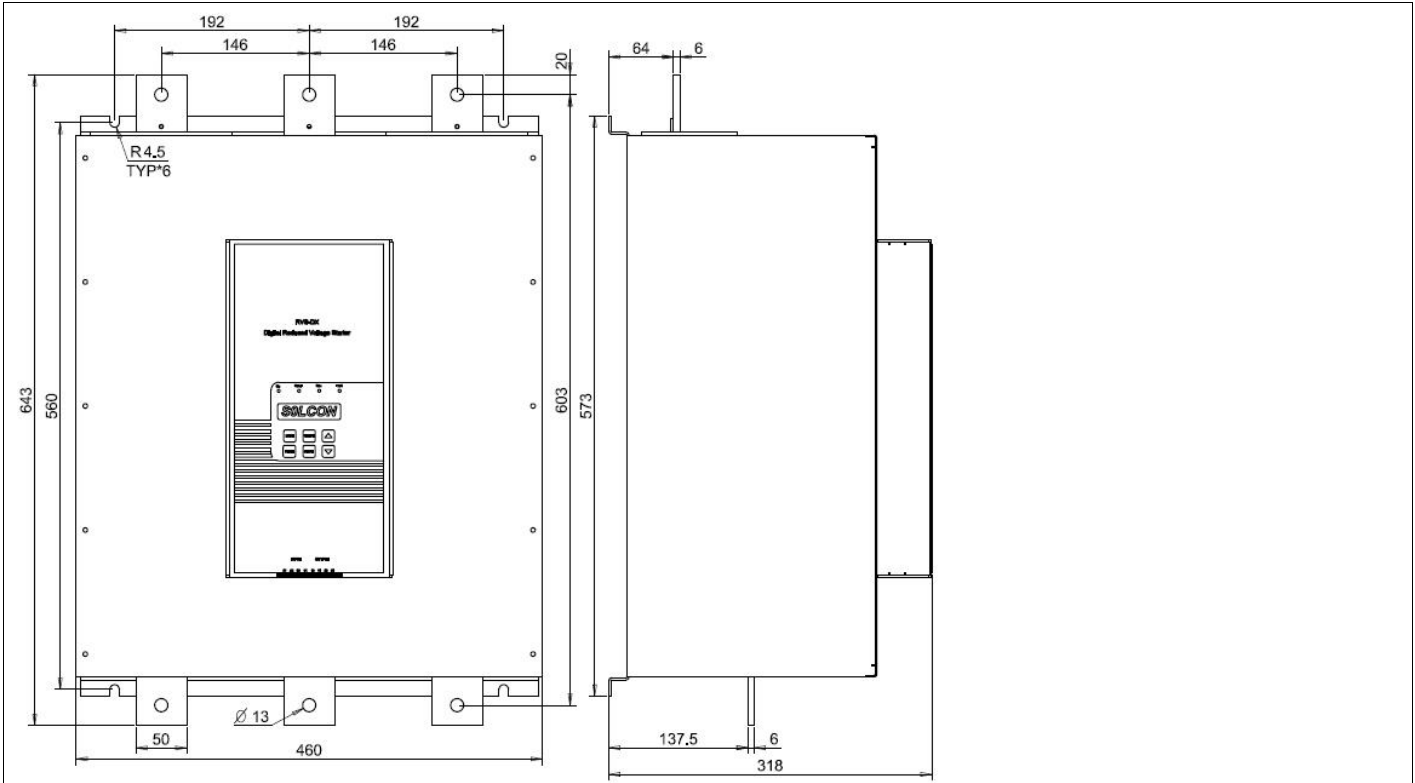

RVS-DX 650-820

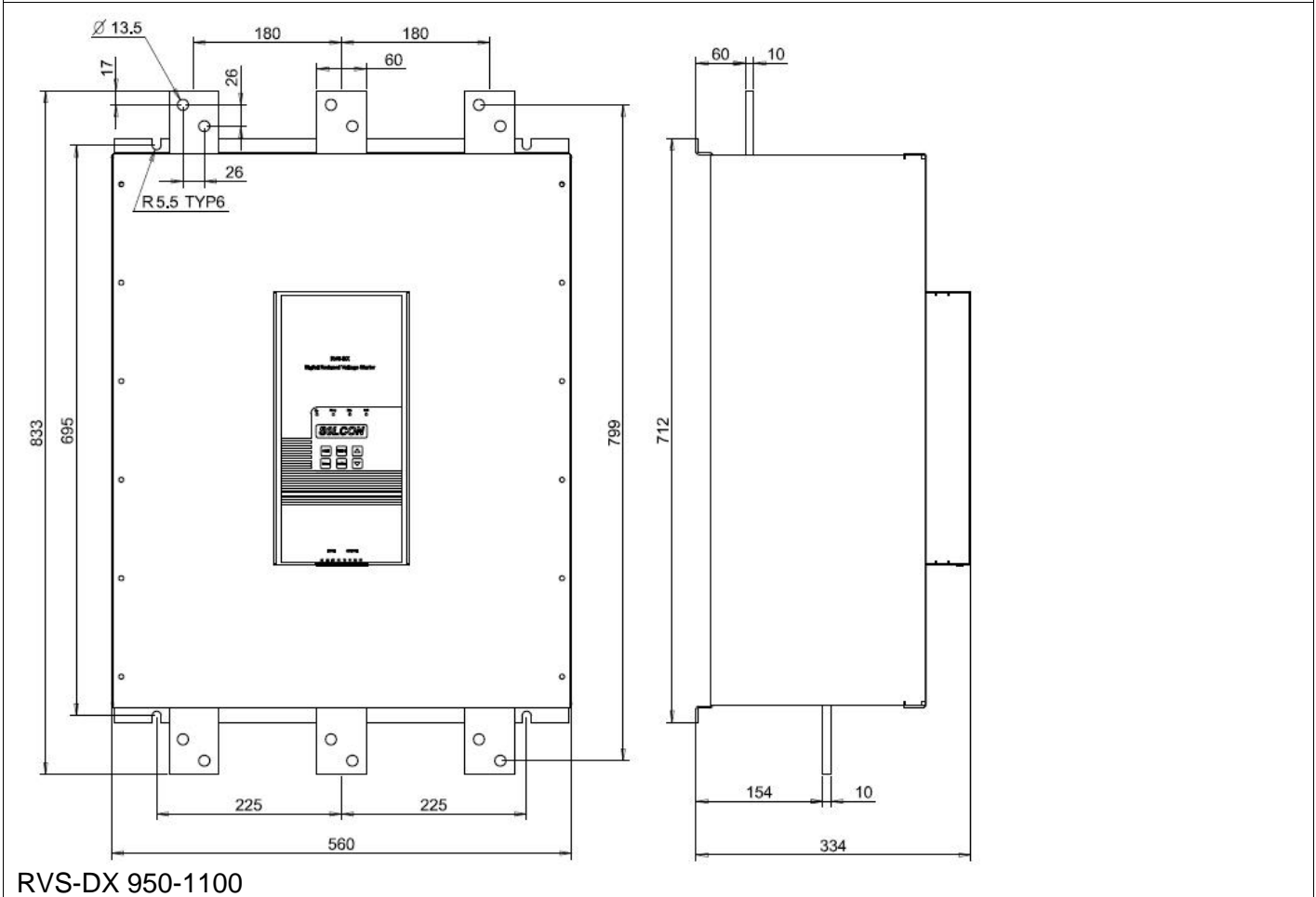

RVS-DX 950-1100

6. INSTALLATION

WARNING!

Do not interchange line and load connections

6.1 Prior to Installation

Check that Motor's Full Load Ampere (FLA) is lower than, or equal, to the starter's Full Load Current (FLC) and that Mains and Control voltages are as indicated on the starter's side label.

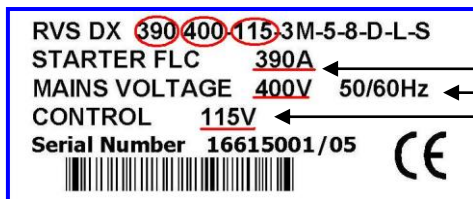

RVS-DX label - example

Make sure Starter's FLC ≥ Motor FLA!
Make sure Mains voltage is right!
Make sure Control voltage is right!

6.2 Mounting

The starter must be mounted vertically. Allow sufficient space (at least 100mm) above and below the starter for suitable airflow.

It is recommended to mount the starter directly on the rear metal plate for better heat dissipation.

Note:

Do not mount the RVS-DX directly on the rear metal plate in case a ventilation fan or ventilation opening is on the back side of the RVS-DX.

Do not mount the starter near heat sources.

Surrounding air temperature in the cabinet should not exceed 40°C

Protect the starter from dust and corrosive atmospheres.

Note: For harsh environments (sewage treatment plants, etc.), it is recommended to order the starter with printed circuit board coating. Refer to section 3.3.6 on page 7 for ordering information.

6.3 Temperature range & heat dissipation

The starter is rated to operate over a temperature range of -10°C (14°F) to + 40°C (104°F).

Relative non-condensed humidity inside the enclosure should not exceed 95%.

ATTENTION!

Operating at surrounding air temp. (Inside the cabinet) higher than 40°C may cause damage to the starter.

Starter's heat dissipation while motor is running and the internal bypass relays are closed is typically less than $0.4 \times I_n$ (in watts). During soft start and soft stop, heating is approximately three times the actual starting current (I_n watts).

Example: For a 100A motor, heat dissipation is less than 40 watts while running and during starting (for example at 350A), heat dissipation is approximately 1050 watts.

Important note: If motor is frequently started, cabinet should be designed for the higher heat dissipation.

Internal enclosure heating can be reduced through the use of additional ventilation.

6.3.1 Calculating the enclosure size, for non-ventilated metallic enclosure

$$\text{Area (m}^2\text{)} = \frac{0.12 \times \text{Total heat dissipation [Watts]}}{60 - \text{External ambient temp. [}^\circ\text{C]}}$$

Where: **Area [m²]** - Surface area that can dissipate heat (front, sides, top).

Total heat dissipation [Watt] – The total heat dissipation of the starter and other control devices in the enclosure. If starter is frequently started, average power should be used.

6.3.2 **Additional Ventilation**

Use the following arrangement for forced ventilation of the RVS-DX's enclosure:

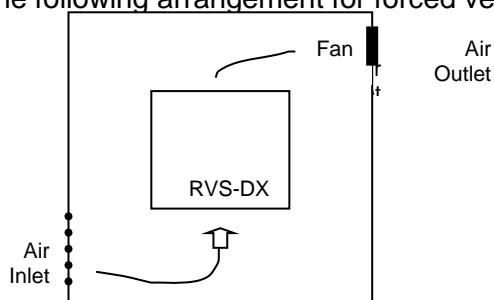

6.3.3 **UL, cUL Installation Instructions**

- Input power and output motor field wiring shall be copper conductors, rated 75°C.
- Use UL listed closed-loop connectors sized for the selected wire gauge. Install connectors using the correct crimp tool recommended by the connector manufacturer. Applies only to units bus bars.
- Table showing corresponding wire size, terminal screw and closed-loop connector size. Torque ratings for attachment of connector to bus bar (refer to table below).
- Branch circuit protection, shall be provided per the NEC.
- For units with UL cUL approval, refer to section 3.3.6 on page 8.

Max. Mot. FLA [A]	Min. dimensions for copper cables [mm ²]	Term Screw	Mechanical Torque [Nm]
8	4 x 1.5 N2XY	M4	1.5
17	4 x 2.5 N2XY	M4	1.5
31	4 x 4 N2XY	M4	1.5
44	4 x 10 N2XY	M4	1.5
58	4 x 16 N2XY	M4	1.5
72	4 x 16 N2XY	M6	3.5
85	4 x 25 N2XY	M8	18.0
105	4 x 25 N2XY	M8	18.0
145	3 x 50 + 25 N2XY	M8	18.0
170	3 x 70 + 35 N2XY	M8	18.0
210	3 x 95 + 50 N2XY	M10	22.0
310	3 x 150 + 70 N2XY	M10	22.0
390	3 x 185 + 95 N2XY	M10	22.0
460	3 x 240 + 120 N2XY	M10	22.0
580	2 x (3x 150 + 70)N2XY	M10	22.0
820	3 x (3x 185+ 95) N2XY	M10	22.0
950		M10	25.0
1100		M10	25.0

7. CONTROL KEYPAD

The control keypad is the link between the Soft Starter and the user.

The RVS-DX control keypad features:

- (1) Two lines of 16 alphanumeric characters each (with five selectable languages – English, French, German, Spanish and Turkish)
- (2) Six push-buttons (**Mode**, **Reset**, **Select**, **Store**, Up (▲) and down (▼) keys).
- (3) Four indication LEDs (*On*, *Ramp*, *Run* and *Fault*)

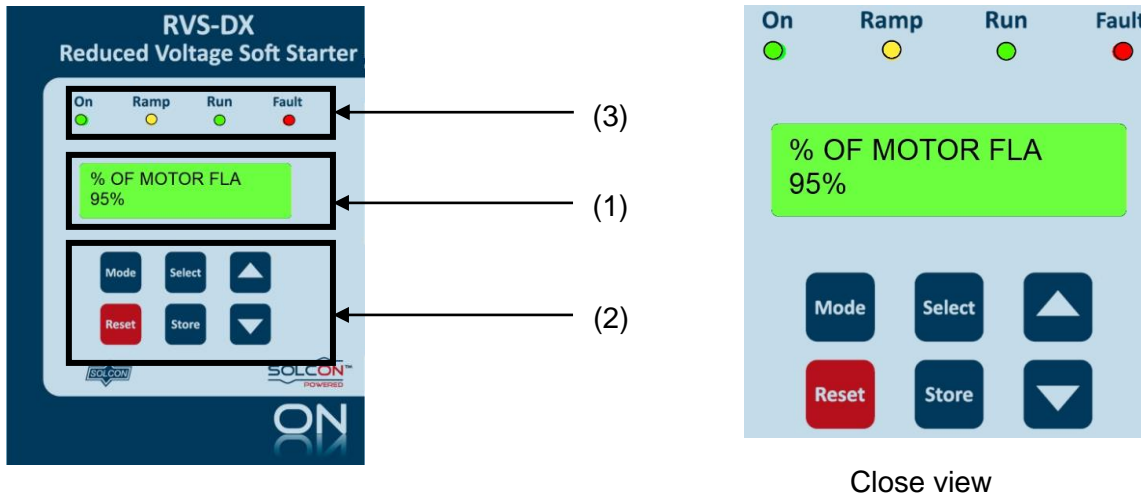

7.1 LCD Arrangement

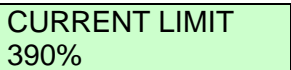





Upper line displays function.

Lower line displays setting and/or measured values.

7.2 Push-buttons

Mode	Scrolls through the display and programming menus of the RVS-DX. Note: Pressing Mode continuously increases the speed at which the parameters change.
Select	When a mode name is displayed, pressing this button drills down to the parameters for that mode. When a parameter is displayed, pressing this button scrolls to the next parameter.
▲	Allows the operator to increment adjusted values shown in the display. Operator should press this button once to increment one value, or continuously to rapidly increment values up to the maximum value.
▼	Allows the operator to decrement adjusted values shown in the display. Operator should press this button once to decrement one value, or continuously to rapidly decrement values up to the minimum value.
Store	Stores modified parameters only when you have scrolled through all parameters and STORE ENABLE XXXXXX PARAMETERS is displayed. After you store a parameter successfully DATA SAVED OK will display. Note: Pressing this button at any other time has no effect.
Reset	Resets the RVS-DX after a fault has been dealt with and the start command has been removed. This cancels the fault displayed and allows you to restart the motor.

7.3 Status LEDs.

	Green	<i>On</i>	Lights when Control Supply voltage is connected to the RVS-DX.
	Yellow	<i>Ramp</i>	Lights during soft start and soft stop process, indicating that motor supply voltage is ramping up or down.
	Green	<i>Run</i>	Lights after completion of starting process, indicating that motor is receiving full voltage.
	Red	<i>Fault</i>	Lights upon operation of any of the built-in protection.

7.4 Reviewing and Modifying Parameters

Press the **Mode** key several times until you reach the required mode page.
Press the **Select** key to review parameters for this mode.

Once you reach the required parameter, use the ▼ or ▲ keys to modify its value.
To store the new parameters, press the **Select** key until the STORE ENABLE message displays and then press the **Store** key. The DATA SAVED OK message will display for 2 seconds.

7.5 Special Actions Performed in TEST/MAINTENANCE Mode

7.5.1 Run Self Test

Press the **Mode** and ▼ keys simultaneously.
The LCD will display:

```
TEST/MAINTENANCE
***OPTIONS***
```

Press the **Select** key.
The LCD will display:

```
RUN SELF TEST?
PUSH UP ARROW
```

Press the ▲ key.
The LCD will display:

```
SELF TEST PASSED
```

And after a few seconds the LCD will display:

```
% OF MOTOR FLA
I<0.1 FLC
```

7.5.2 View Software Version

Press the **Mode** and ▼ keys simultaneously.
The LCD will display:

```
TEST/MAINTENANCE
***OPTIONS***
```

Press the **Select** key **twice**.
The LCD will display:

```
BTL-R-17/05/2009
STRT.DX-310111
```

Press the **Mode** and ▼ keys simultaneously to exit the TEST/MAINTENANCE mode.
The LCD will display:

```
% OF MOTOR FLA
I<0.1 FLC
```

7.5.3 Obtain Default Parameters

Press the **Mode** and ▼ keys simultaneously.

The LCD will display:

```
TEST/MAINTENANCE
***OPTIONS***
```

Press the **Select** key **three times**.

The LCD will display:

```
STORE      ENABLE
DEFAULT PARAMET.
```

Press the **Store + Mode** keys simultaneously.

The LCD will display:

```
DATA SAVED OK
```

And after a few seconds the LCD will display:

```
% OF MOTOR FLA
I<0.1 FLC
```

CAUTION!

Obtaining DEFAULT PARAMETERS erases all previously modified settings and requires the operator to **reprogram** all parameters that differ from the factory default.

Note: It is especially important to reprogram the **FLC** (as shown on the label of the RVS-DX), **FLA** and **RATED LINE VOLT.** value again.

7.5.4 Reset Statistical Data

Press the **Mode** and ▼ keys simultaneously.

The LCD will display:

```
TEST/MAINTENANCE
***OPTIONS***
```

Press the **Select** key **four times**.

The LCD will display:

```
RESET STATISTICS
```

Press the **Reset + Store** keys simultaneously.

The LCD will display:

```
DATA SAVED OK
```

And after a few seconds the LCD will display:

```
STATISTICAL DATA
- **** -
```

Press the **Mode** and go back to:

```
% OF MOTOR FLA
I<0.1 FLC
```

7.5.5 Calibrate Voltage, Current and (Factory Use Only!)

Press the **Mode** and ▼ keys simultaneously.

the LCD will display:

```
TEST/MAINTENANCE
***OPTIONS***
```

Press the **Select** key **five times**.

The LCD will display:

```
VOLTAGE ADJUST.
X VOLT
```

Press the **Select** key.

The LCD will display:

```
CURRENT ADJUST.
5% OF FLC
```

Press the **Select** key.

The LCD will display (POWER FACTOR & POWER measurement only available in RVS-DX58A and up):

```
POWER FACTOR
0.71
```

Press the **Mode** and ▼ keys simultaneously to exit the TEST/MAINTENANCE mode.

7.6 Mode Pages

Upon initiation of the starter, the LCD displays motor's operating current:

```
% OF MOTOR FLA
0%
```

By pressing the **Mode** key all mode pages can be reviewed:

```
MAIN PARAMETERS
- **** -
```

```
START PARAMETERS
- **** -
```

```
STOP PARAMETERS
- **** -
```

```
DUAL ADJUSTMENT
PARAMETERS
```

```
SPECIAL FEATURES
PARAMETERS
```

```
FAULT PARAMETERS
- **** -
```

```
I/O PROGRAMMING
PARAMETERS
```

```
COMM PARAMETERS
- **** -
```

```
STATISTICAL DATA
- **** -
```

These pages are skipped if RVS-DX is programmed to "MINIMIZED MODE" and are shown only in "MAXIMIZED MODE" (Refer to section 7.6.3 on page 28 for information on changing from "MINIMIZED MODE" to "MAXIMIZED MODE")

7.6.1 Overview of All Mode Pages and Factory Defaults

				Appears only in MAXIMIZED MODE ⁽¹⁾	
% OF MOTOR FLA XX%	MAIN PARAMETERS	START PARAMETERS	STOP PARAMETERS	DUAL ADJUSTMENT PARAMETERS	
Refer page 27	Refer page 28	Refer page 32	Refer page 36	Refer page 38	
AMP. 0	VOLT 0	LANGUAGE: ENGLISH	SOFT START CURVE 0(STANDARD)	SOFT STOP CURVE 0(STANDARD)	DA: INIT. VOLT. 30%
OPTION CARD Not Installed	STARTER FLC 58 AMP.	PULSE TIME 0 SEC.	DEC. TIME 0 SEC.	DA: CUR. LIMIT 400% OF FLA	
POWER ⁽²⁾	MOTOR FLA 58 AMP.	INITIAL VOLTAGE 30 %	FINAL TORQUE 0 (MIN.)	DA: ACC. TIME 10 SEC.	
POWER FACTOR ⁽²⁾	RATED POWER 30KW	CURRENT LIMIT 400% OF FLA	STORE ENABLE STOP PARAMETERS	DA: DEC. TIME 0 SEC.	
CONNECTION TYPE LINE		ACC. TIME 10 SEC.	DA: MOTOR FLA 31 AMP.		
RATED LINE VOLT. 400 VOLT		MAX. START TIME 30 SEC.	STORE ENABLE D. ADJ PARAMETERS		
UNDERCURREN. TRIP 0% OF FLA		NUMBER OF STARTS 10			
UNDERCURREN. DELAY 10 SEC.		STARTS PERIOD 30 MIN.			
O/C – SHEAR PIN 200% OF FLA		START INHIBIT 15 MIN.			
O/C DELAY 0.5 SEC.		STORE ENABLE START PARAMETERS			
OVERLOAD CLASS IEC CLASS 10					
OVERLOAD PROTECT ENABLE WHILE RUN					
UNDERVOLT. TRIP 75%					
UNDERVOLT. DELAY 5 SEC.					
OVERVOLT. TRIP 120 %					
OVERVOLT. DELAY 2 SEC.					
DISPLAY MODE MINIMIZED					
PARAMETERS LOCK NOT LOCKED					
START ON DELAY 0SEC					
STORE ENABLE MAIN PARAMETERS					

(1) - Refer to section 7.6.3 on page 28 for information on changing from “MINIMIZED MODE” (Factory default) to “MAXIMIZED MODE”.

(2) POWER and POWER FACTOR readings available in RVS-DX 58A and up.

Appears only in MAXIMIZED MODE ⁽¹⁾	Appears only in MAXIMIZED MODE ⁽¹⁾	Appears only in MAXIMIZED MODE ⁽¹⁾	Appears only in MAXIMIZED MODE ⁽¹⁾	
SPECIAL FEATURES PARAMETERS	FAULT PARAMETERS	I/O PROGRAMMING PARAMETERS	COMM. PARAMETERS	STATISTICAL DATA
Refer page 39	Refer page 41	Refer page 43	Refer page 45	Refer page 47
SLOW SPEED TORQ. 8	PHASE LOSS Y/N YES	PROG. INPUT C1 REMOTE RESET	COMM. PROTOCOL MODBUS	TOTAL ENERGY ⁽³⁾ 0 KWH
MAX SLOW SP TIME 30 SEC.	PHASE SEQ. Y/N NO	FAULT RELAY TYPE FAULT	BAUD RATE 9600 (MODBUS)	LAST STRT PERIOD NO DATA
WIDER SETTINGS DISABLE	INSULATION ALARM OFF	PROG. AUX. RELAY IMMEDIATE	PARITY CHECK EVEN	LAST START MAX I NO DATA
STORE ENABLE SPECIAL FEATURES	INSULATION TRIP OFF	RELAY ON DELAY 0 SEC.	SERIAL LINK NO. OFF	TOTAL RUN TIME 0 HOURS
	AUTO RESET NO	RELAY OFF DELAY 0 SEC.	S. LINK PAR. SAVE DISABLE	TOTAL # OF START 0
	THERMISTOR TYPE PTC	AN. OUT. PARAMETER I, 0...200% OF FLA	SER. LINK CONTROL DISABLE	LAST TRIP NO DATA
	THERMISTOR TRIP OFF	STORE ENABLE I/O PROG. PARAM.	MODBUS TIMEOUT OFF	TRIP CURRENT 0 % OF FLA
	UNDER CUR. RESET OFF		FRONT COM ADDRES OFF	TOTAL # OF TRIPS 0
	STORE ENABLE FAULT PARAMETERS		STORE ENABLE COMM. PARAMETERS	PREVIOUS TRIP -2 NO DATA
			Applicable when Optional Modbus or DeviceNet is ordered. ↑	▪
			Applicable when Optional Profibus Is ordered. ↓	▪
			COMM. PROTOCOL PROFIBUS	PREVIOUS TRIP -9 NO DATA
			BAUD RATE AUTO (PROFIBUS)	
			PARITY CHECK AUTO (PROFIBUS)	Appears when in TEST/MAINTENANCE⁽²⁾ TEST/MAINTENANCE ***OPTIONS*** Display and default values
			PROFI.NETWORK ID OFF	RUN SELF TEST? PUSH UP ARROW
			S. LINK PAR. SAVE DISABLE	BTL-R-29/05/2008 STRT.DX-250608
			SER. LINK CONTROL DISABLE	STORE ENABLE DEFAULT PARAMETERS
			MODBUS TIMEOUT OFF	RESET STATISTICS
			FRONT COM ADDRES OFF	VOLTAGE ADJUST X VOLT
			STORE ENABLE COMM. PARAMETERS	CURRENT ADJUST 5% OF FLC
				POWER FACTOR ⁽³⁾ 0.71

(1) - Refer to section 7.6.3 on page 28 for information on changing from “MINIMIZED MODE” (Factory default) to “MAXIMIZED MODE”.

⁽²⁾ - Refer to section 7.5 on page 21 for entering TEST/MAINTENANCE mode.

⁽³⁾ – TOTAL ENERGY and POWER FACTOR readings available in RVS-DX 58A and up.

7.6.2 **Display Mode – page 0**

% OF MOTOR FLA XX%	Displays in MINIMIZED MODE and MAXIMIZED MODE (Refer to section 7.6.3 page 28)	
Display and default values	Range	Description
% OF MOTOR FLA I<0.1 FLC		Displays operating current as a percentage of motor FLA (Full Load Ampere). Starter's Default Display. After pressing Mode or Select keys, a time delay is initiated. Following the delay, the LCD returns to display "% OF MOTOR FLA".
AMP. VOLT 0 0		Displays Motors current and mains voltage.
OPTION CARD Not Installed	NOT INSTALLED/ INSTALLED	Displays whether option cards are installed in the RVS-DX.
POWER 30kw		When power metering option is installed, displays active POWER drawn by the motor. Note: Reading available in RVS-DX58A and up.
POWER FACTOR 0.9		When power metering option is installed, displays POWER FACTOR of motors power. Note: Reading available in RVS-DX58A and up.

Note:

In this page parameters cannot be programmed.

7.6.3 Main Parameters – page 1

MAIN PARAMETERS _ **** _	Displays in MINIMIZED MODE and MAXIMIZED MODE (Refer below for changing modes)		
Display and default values	Range	Description	Remarks
LANGUAGE: ENGLISH	SPANISH GERMAN FRENCH ENGLISH TURKCE RUSSIAN (Optional)	Sets Starter's language	
STARTER FLC 58 AMP.	8-1100A	Sets starter's FLC (Full load current)	Starter's FLC should be as shown on starter's Name plate. (Refer to section 6.1 on page 18)
MOTOR FLA 58 AMP.	50-100% of STARTER FLC	Sets motor's FLA (Full load Ampere)	Should be programmed as shown on motor's name plate. Note: When the RVS-DX is installed Inside Delta set MOTOR FLA = $\langle \text{rated motor current} \rangle / 1.73$.
RATED POWER 30KW	1-3000KW	Sets motor's POWER	Rated motor power is used for analog output reference. When analog card is installed, full scale of the readings (20mA or 10V as per dip-switches settings on the analog card) are related to 200%FLA. (2x rated motor current) or 200% of rated power or POWER FACTOR. Refer to section 7.6.9 on page 43 for analog output programming. Note: POWER FACTOR & POWER measurement only available in RVS-DX58A and up.
CONNECTION TYPE LINE	LINE, INSIDE DELTA	Sets Starter's connection type.	Factory preset – features and functions when "INSIDE DELTA" mode is configured: No Pulse Start. No Curve selection (CURVE 0!!). No slow speed. No phase sequence "off" mode. Refer to section 4.3.9 on page 12 for further information
RATED LINE VOLT. 400 VOLT	220-690V	Sets rated LINE VOLTAGE.	
UNDERCURREN. TRIP 0% OF FLA	0%=off; 20-90% of FLA	Sets UNDER CURRENT TRIP protection.	Trips the starter when motor current drops below set level for a time longer than UNDER CURRENT DELAY
UNDERCURREN. DELAY 10 SEC.	1-40sec.	Sets the time delay for the	

MAIN PARAMETERS - **** -	Displays in MINIMIZED MODE and MAXIMIZED MODE (Refer below for changing modes)														
Display and default values	Range	Description	Remarks												
		UNDER CURRENT TRIP protection													
O/C – SHEAR PIN 200% OF FLA	100-300% of motor's FLA setting	Sets OVER CURRENT SHEAR PIN protection	<p>becomes operational when starter is energized and has three trip functions:</p> <p>At all time - IF I > 850% of FLC - trips the starter within 1 cycle. (Overrides the value of O/C – SHEAR PIN setting)</p> <p>At starting process - IF I > 850% of FLA - trips the starter after O/C DELAY (see here after)</p> <p>At run time - IF I > O/C – SHEAR PIN setting of FLA - trips the starter after O/C DELAY</p> <p>Important Note: The O/C SHEAR PIN is not intended to replace the fast acting fuses, required to protect the thyristors (Refer to fuse table in section 4.3.1 on page 10)</p>												
O/C DELAY 0.5 SEC.		0.0 –5sec.		Sets O/C – SHEAR PIN delay time											
OVERLOAD CLASS IEC CLASS 10	IEC CLASS 10/ IEC CLASS 20/ NEMA CLASS 10/ NEMA CLASS 20/ NEMA CLASS 30/	Sets OVERLOAD curve.	<p>Sets OVERLOAD CLASS characteristics Sets OVERLOAD PROTECT functionality. The HRVS-DN allows motor protection according to IEC class 5 or 10 or according to NEMA class 10 ,20 or 30. Tripping curves are shown on section 7.6.3.1 page 31. The OVERLOAD protection incorporates a THERMAL CAPACITY register that calculates heating minus dissipation of the motor. The RVS-DX trips when the register fills up. (THERMAL CAPACITY=100%) The time constant, in seconds, for cool down after overload trip is:</p> <table border="1"> <thead> <tr> <th>Class</th> <th>10</th> <th>20</th> <th>30</th> </tr> </thead> <tbody> <tr> <td>IEC</td> <td>320</td> <td>640</td> <td>-</td> </tr> <tr> <td>NEMA</td> <td>280</td> <td>560</td> <td>840</td> </tr> </tbody> </table>	Class	10	20	30	IEC	320	640	-	NEMA	280	560	840
Class				10	20	30									
IEC	320	640	-												
NEMA	280	560	840												
OVERLOAD PROTECT ENABLE WHILE RUN	DISABLE/ ENABLE WHILE RUN/ ENABLE		<p>The overload protection can be set to protect the motor as set in the OVERLOAD PROTECT parameter:</p> <p>ENABLE – motor is protected at all time.</p> <p>ENABLE WHILE RUN – motor is protected only when in Run.</p> <p>DISABLE – motor is not overload protected by the soft starter.</p> <p>Note: In order to restart after OVERLOAD trip, the thermal register should be 50% or less.</p>												
UNDERVOLT. TRIP 75%	50-90% of RATED LINE VOLT.	Sets UNDER VOLTAGE TRIP.	Trips the starter when mains voltage drops below the set level for a time longer than UNDERVOLT DELAY.												

MAIN PARAMETERS - **** -	Displays in MINIMIZED MODE and MAXIMIZED MODE (Refer below for changing modes)		
Display and default values	Range	Description	Remarks
UNDERVOLT. DELAY 5 SEC.	1–10sec.	Sets UNDERVOLT TRIP DELAY.	Note: Becomes operational only after Start signal. When voltage drops to zero (voltage outage) the starter will trip immediately, overriding the delay.
OVERVOLT. TRIP 120 %	110-125% of RATED LINE VOLT.	Sets OVER VOLTAGE TRIP.	Trips the starter when mains voltage increases above the set level for a time longer than OVEERVOLT DELAY.
OVERVOLT. DELAY 2 SEC.			
DISPLAY MODE MINIMIZED	MINIMIZED/ MAXIMIZED	Sets Display Mode	For operation convenience, there are two display modes: MINIMIZED – Display of pre-selected parameters for standard applications. MAXIMIZED – Display of all possible parameters. Setting Display Mode to MINIMIZED will minimize the LCD displays. (Refer to section 7.47.6 on page 21 for more details)
PARAMETERS LOCK NOT LOCKED	NOT LOCKED/ LOCKED	Locks or unlocks parameter modifications.	The software lock prevents undesired parameter modification. When locked, upon pressing Store , ▼ or ▲ keys, the LCD displays: <div style="border: 1px solid black; padding: 2px; width: fit-content; margin: 5px auto;">UNAUTHORIZED ACCESS</div>
START ON DELAY 0sec	0-2sec	The SST ignores the voltage until end of delay	The Line Contactor Enable the use of the immediate relay to control the Line cont.
STORE ENABLE MAIN PARAMETERS		Storing modified parameters	To store selected parameters, press Store key. Note: Storing selected parameters is possible only when <i>RAMP</i> LED does not lit. Storing cannot be done when Soft Starting or Soft Stopping. When parameters have been correctly stored, the LCD will read: <div style="border: 1px solid black; padding: 2px; width: fit-content; margin: 5px auto;">DATA SAVED OK</div> <u>This concludes MAIN PARAMETER settings.</u> Pressing Select key after “DATA SAVED OK” returns to the first display in this mode. Note: In case of a failure in parameter storing, the LCD displays: <div style="border: 1px solid black; padding: 2px; width: fit-content; margin: 5px auto;">STORAGE ERROR</div> In this case Refer to section 9 – “TROUBLE SHOOTING” on page 57.

7.6.3.1 Tripping Curves of the Integrated Overload Protection

The RVS-DX allows motor protection according to IEC class 10 or 20 OR according to NEMA class 10, 20, or 30.

NEMA & IEC Class OVERLOAD curves

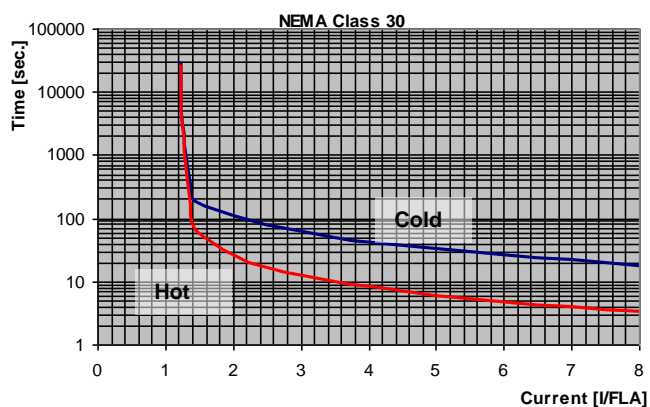
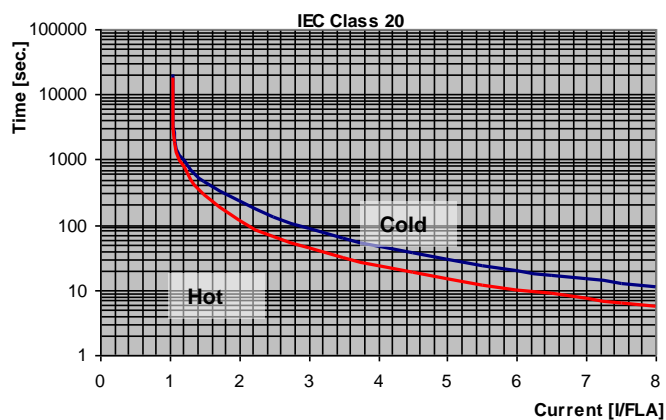
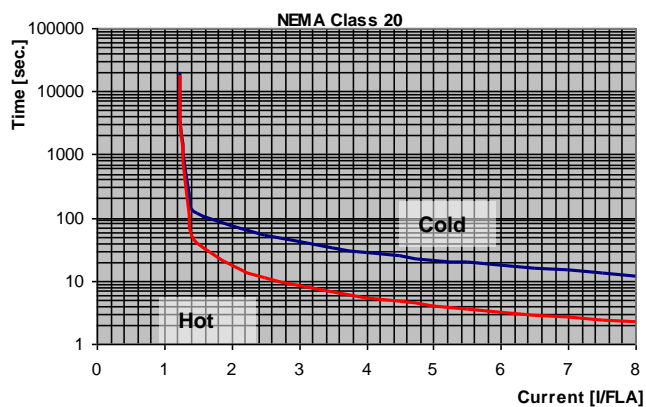
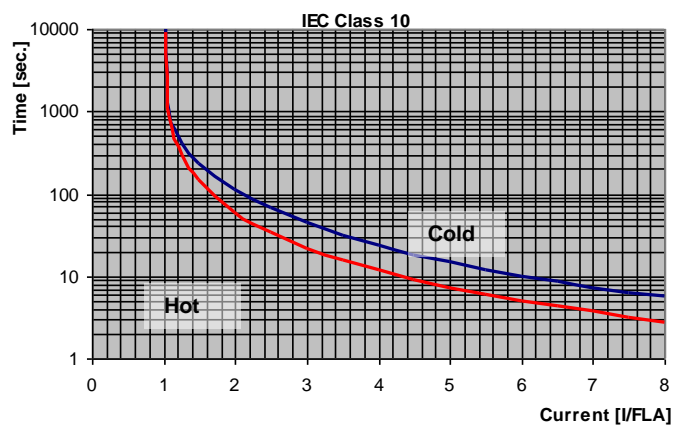
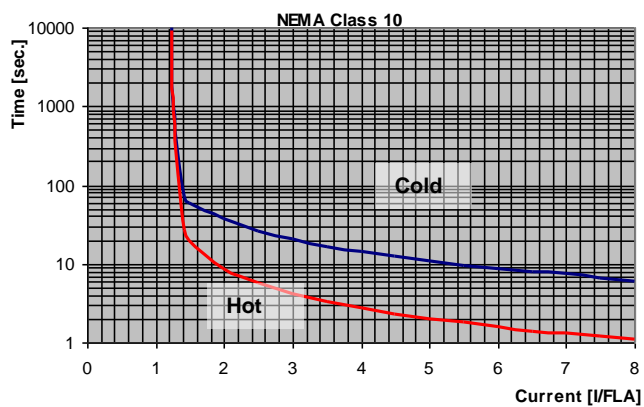

7.6.4 Start Parameters – page 2

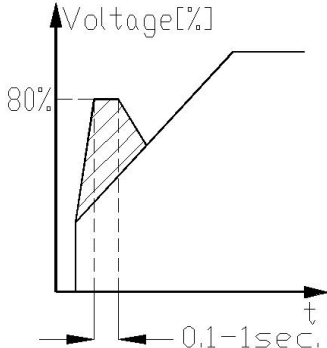
START PARAMETERS - **** -		Displays in MINIMIZED MODE and MAXIMIZED MODE (refer to section 7.6.3 on page 28 for changing mode)	
Display and default values	Range	Description	Remarks
SOFT START CURVE 0(STANDARD)	4 (TORQUE) 3 !! 2 !! 1 !! 0 (STANDARD)	Sets starter's SOFT START CURVE.	Refer to section 7.6.4.1 on page 35. Note: When RVS-DX is connected "Inside-Delta", only CURVE 0 is applied.
PULSE TIME 0 SEC.	0 – 1.0 SEC.	Sets starter's PULSE START TIME. PULSE START level is 80% Un.	Intended to start high friction loads, requiring high starting torque for a short time. A pulse of 80% Un, <u>without</u> Current Limit, is initiated to break the load free. Pulse duration is adjustable, 0.1 – 1sec. After this pulse, the voltage is ramped down to INITIAL VOLTAGE setting, before ramping up again to full voltage according to START PARAMETERS settings. 
INITIAL VOLTAGE 30 %	10-50% After reaching 50% display changes to: INITIAL CURRENT 100-400% Note: The range of the INITIAL VOLTAGE can be extended to 5-80% by using the WIDER	Sets motor's INITIAL STARTING VOLTAGE. (Motor's torque is directly proportional to the square of the voltage)	This adjustment also determines the inrush current and mechanical shock. A setting that is too high may cause high initial mechanical shock and high inrush current (even if CURRENT LIMIT is set low, as the INITIAL VOLTAGE setting overrides CURRENT LIMIT setting). A setting that is too low may result in prolonged time until motor begins to turn. In general, this setting should ensure that the motor begins turning immediately after start signal.
INITIAL CURRENT 100 %			

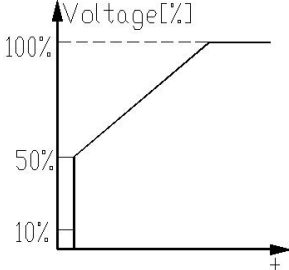
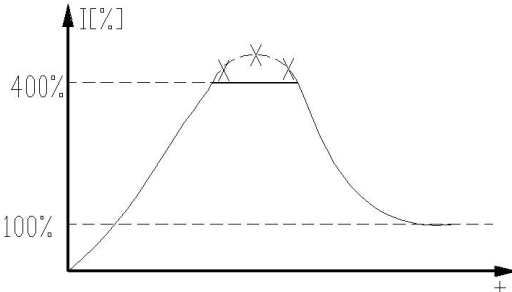
START PARAMETERS - **** -	Displays in MINIMIZED MODE and MAXIMIZED MODE (refer to section 7.6.3 on page 28 for changing mode)		
	SETTING as described in section 7.6.7 page 39.		<p>Note: When INITIAL VOLTAGE is set above 50% (it's maximum value), display changes to INITIAL CURRENT. When INITIAL CURRENT is set, starter causes current ramp instead of voltage ramp.</p> 
CURRENT LIMIT 400% OF FLA	100-400% Note: Range can be extended to 100-500% by using the WIDER SETTING as described in section 7.6.7 page 39.	Sets motor's highest current during starting.	<p>A too high setting will cause greater current drawn from mains and faster acceleration. A setting that is too low may prevent motor from completing acceleration process and reaching full speed. In general, this setting should be set to a high enough value in order to prevent stalling.</p> <p>Note: CURRENT LIMIT is not operating during Run and Soft stop.</p> 
ACC. TIME 10 SEC.	1-30sec. Note: Range can be	Sets ACCELERATION TIME of the	Determines motor's voltage ramp-up time, from initial to full voltage.

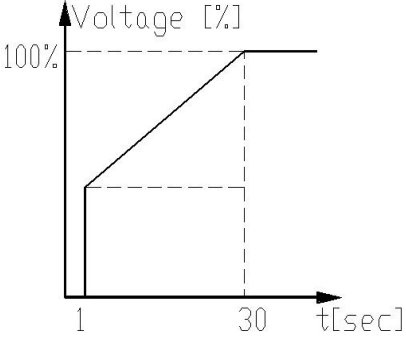
START PARAMETERS - **** -	Displays in MINIMIZED MODE and MAXIMIZED MODE (refer to section 7.6.3 on page 28 for changing mode)		
	extended to 1-90sec. by using the WIDER SETTING as described in section 7.6.7 page 39.	motor.	It is recommended to set ACCELERATION TIME to the minimum acceptable value (approx. 5 sec).  <p>Notes: Since CURRENT LIMIT overrides ACC. TIME, when CURRENT LIMIT is set low, starting time will be longer than the preset ACC. TIME. When motor reaches full speed before voltage reaches nominal, ACC. TIME setting is overridden, causing voltage to quickly ramp-up to nominal. Using starting curves 1, 2, 3 prevents quick ramp up.</p>
MAX. START TIME 30 SEC.	1-30sec. Note:	Sets MAXIMUM START TIME	The maximum allowable start time, from Start signal to end of acceleration process. If voltage does not reach full voltage/speed during this time (e.g. because of too low CURRENT LIMIT setting), the starter will trip the motor. LCD displays "LONG START TIME" message.
	Range can be extended to 1-250sec.by using the WIDER SETTING as described in section 7.6.7 page 39.		
NUMBER OF STARTS 10	OFF, 1-10	Sets NUMBER OF STARTS permitted During STARTS PERIOD (see below).	Limits the NUMBER OF STARTS during the period of time defined by STARTS PERIOD. If you try to start even one more time within that period the START INHIBIT period will take effect.
			During the START INHIBIT period the WAIT BEFORE RST XX MIN message will be displayed.
STARTS PERIOD 30 MIN.	1-60min.	Sets STARTS PERIOD during which NUMBER OF STARTS is being counted.	
START INHIBIT 15 MIN.	1-60min.	Sets START INHIBIT time which, before elapsed, motor can not be restarted.	
STORE ENABLE START PARAMETERS			Same as STORE ENABLE MAIN PARAMETERS on page 30.

7.6.4.1 Soft start parameters

The RVS-DX incorporates 4 “Starting Curves”, enabling selection the suitable torque curve:

Start Curve 0 – Standard curve (Default). The most stable and suitable curve for the motor, preventing prolonged starting and motor overheating.

Note:

When RVS-DX is connected “Inside-Delta”, only CURVE 0 is applied.

Start curves 1-3 - “Pump Control” - Induction motors produce peak torque of up to 3 times the rated torque towards the end of starting process. In some pump applications, this peak may cause high pressure in the pipes.

Start Curves 1, 2, 3 – During acceleration, before reaching peak torque, the Pump Control Program automatically controls the voltage ramp-up, reducing peak torque.

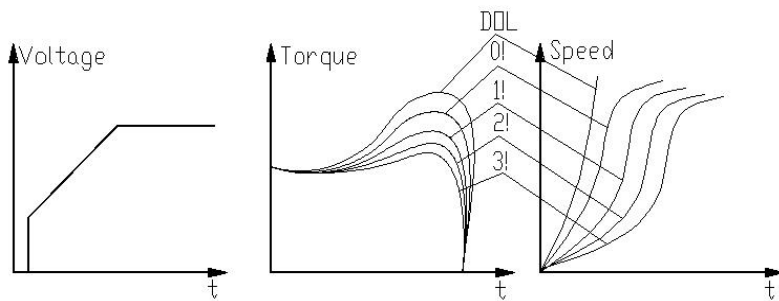

Choice of three pump control acceleration curves: 0!, 1!, 2!, 3!

Start Curve 4 (Torque) – Torque Controlled acceleration, provides a smooth time controlled torque ramp for the motor and the pump.

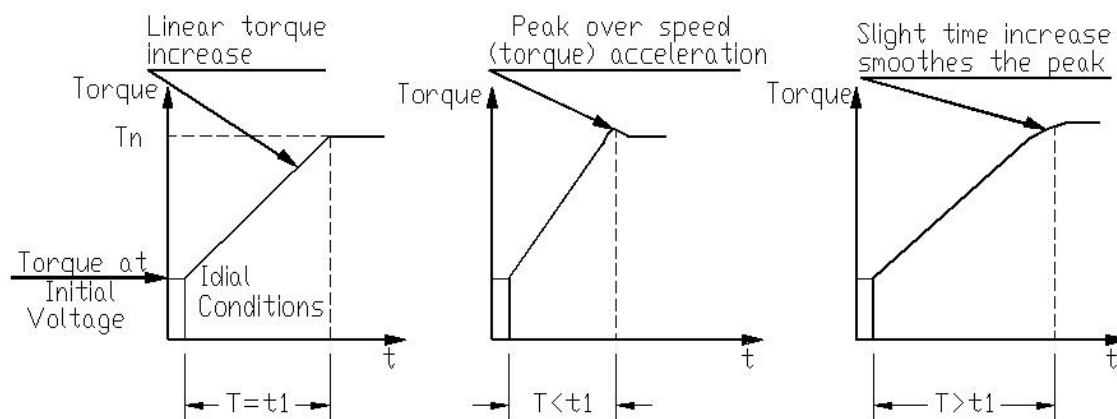

Note:

Always start with Start Curve 0. If towards end of acceleration, peak torque is too high (pressure is too high), proceed to Curve 1, 2, 3 or 4 if necessary.

7.6.5 Stop Parameters – page 3

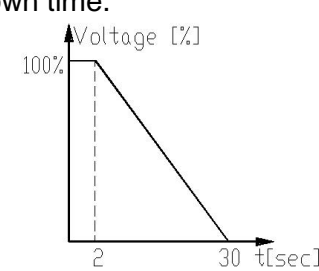
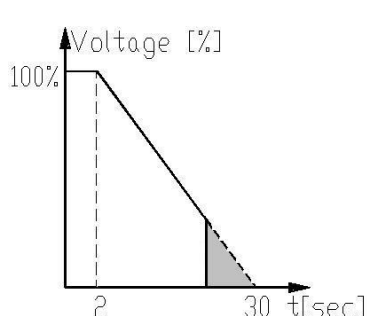
STOP PARAMETERS _****_	Displays in MINIMIZED MODE and MAXIMIZED MODE (refer to section 7.6.3 on page 28 for changing mode)		
Display and default values	Range	Description	Remarks
SOFT STOP CURVE 0(STANDARD)	4 (TORQUE) 3 !! 2 !! 1 !! 0 (STANDARD)	Sets starter's SOFT STOP CURVE.	Refer to section 7.6.5.1 on page 36
DEC. TIME 0 SEC.	0 – 30sec. Note: Range can be extended to 90sec. by using the WIDER SETTING as described in section 7.6.7 page 39.	Sets DECELERATION TIME of the motor.	Used for controlled deceleration of high friction loads. Determines motor's voltage ramp down time. 
FINAL TORQUE 0 (MIN.)	0 (min.) – 10 (max.)	Sets FINAL TORQUE during Soft Stop.	Determines torque towards end of SOFT STOP. If current is still flowing after speed is softly reduced to zero, increase FINAL TORQUE setting. 
STORE ENABLE STOP PARAMETERS			Same as STORE ENABLE MAIN PARAMETERS on page 30.

7.6.5.1 Soft stop parameters

The RVS-DX incorporates 4 “Starting Curves”, enabling selection the suitable torque curve:

Stop Curve 0 – Standard curve (Default) – voltage is linearly reduced from nominal to zero. The most stable and suitable curve for the motor, preventing prolonged stopping and motor overheating.

Stop curves 1, 2, 3 Pump Control – In some pump applications, when pumping to a higher level, a considerable part of the torque is constant and does not decrease with speed. It may happen that during deceleration process, when voltage is decreasing, motor torque quickly falls below load torque abruptly (instead of smoothly decreasing speed to zero) closing the valve and causing Water Hammer. Curves 1, 2 and 3 are intended to prevent Water Hammer phenomenon. In pump applications, load torque decreases in square relation to the speed, thus correct control of voltage reduction reduces torque adequately to smoothly decelerate to a stop.

Note:
It is recommended that for all standard applications (not pumps), Stop Curve 0 will be used.

To reduce Water Hammer select STOP CURVE 1, than 2 or 3, if necessary.

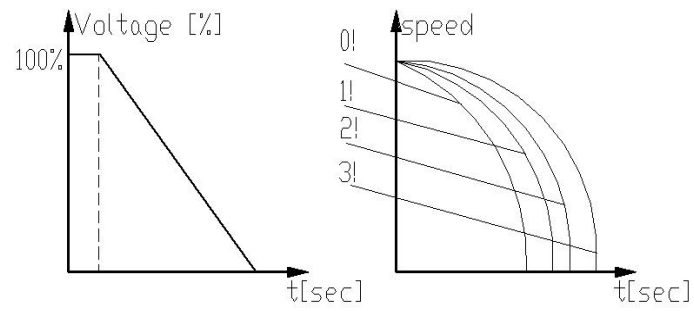

Curve 4 - Torque Curve - Provides linear deceleration of the torque. In certain loads, linear torque deceleration can result in close to linear speed deceleration.

The RVS-DX Torque Control does not require any external torque or speed sensor (tacho-gen. etc.).

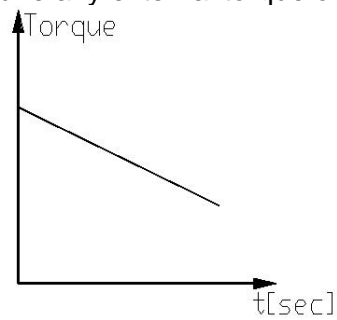

7.6.6 **Dual Adjustment Parameters – page 4**

Displays in MAXIMIZED MODE only (refer to section 7.6.3 on page 28 for changing mode)		
DUAL ADJUSTMENT PARAMETERS	Description	Remarks
Display and default values		When selecting GEN. START/STOP in mode I/O PROGRAMMING PARAMETERS on page PROG. INPUT C1 DUAL ADJUST (refer to section 7.6.9.1 on page 44) the following display appears: <div style="border: 1px solid black; padding: 5px; margin: 10px auto; width: fit-content;">D. ADJ: GENERATOR PARAMETERS</div>
DA: INIT. VOLT. 30%	Sets motor's INITIAL STARTING VOLTAGE in DA mode. (Motor's torque is directly proportional to the square of the voltage)	Refer to section 7.6.4 on page 32 parameter: INITIAL VOLTAGE.
DA: INIT. CURRENT 100%		
DA: CUR. LIMIT 400% OF FLA	Sets motor's highest current during starting in DA mode.	Refer to section 7.6.4 on page 32 parameter: CURRENT LIMIT.
DA: ACC. TIME 10 SEC.	Sets ACCELERATION TIME of the motor in DA mode.	Refer to section 7.6.4 on page 32 parameter: ACC. TIME.
DA: DEC. TIME 0 SEC.	Sets DECELERATION TIME of the motor in DA mode.	Refer to section 7.6.5 on page 36 parameter: DEC. TIME.
DA: MOTOR FLA 31 AMP.	Sets motor's FLA (Full load Ampere) in DA mode.	Refer to section 7.6.3 on page 27 parameter: MOTOR FLA.
STORE ENABLE D. ADJ PARAMETERS		Same as STORE ENABLE MAIN PARAMETERS on page 30.

7.6.7 **Special features Parameters – page 5**

SPECIAL FEATURES PARAMETERS	Displays in MAXIMIZED MODE only (refer to section 7.6.3 on page 28 for changing mode)		
Display and default values	Range	Description	Remarks
SLOW SPEED TORQ. 8	1(MIN.) – 10(MAX.)	Sets SLOW SPEED TORQUE.	Note: When RVS-DX is connected “Inside-Delta” SLOW SPEED TORQUE is not available.
MAX SLOW SP TIME 30 SEC.	1–30sec. Note: Range can be extended to 250sec. by using the WIDER SETTING as described in section 7.6.7 page 39.	Sets maximum time for SLOW SPEED TORQUE operation.	
WIDER SETTINGS DISABLE	DISABLE/ ENABLE	Enables wider range of parameter settings.	For use in very special occurrences. Do not set to ENABLE unless starter is significantly larger then motor! See detailed explanation next page.
STORE ENABLE SPECIAL FEATURES			
			Same as STORE ENABLE MAIN PARAMETERS on page 30.

7.6.7.1 WIDER SETTINGS Parameters:

Parameter	WIDER SETTINGS Disabled	WIDER SETTINGS Enabled
INITIAL VOLTAGE	10-50%	5 ⁽¹⁾ -80%
CURRENT LIMIT	100-400%	100-500%
ACCELERATION TIME	1-30 seconds	1-90 seconds
DECELERATION TIME	0-30 seconds	0-90 seconds
MAX. START TIME	1-30 seconds	1-250 seconds
PHASE LOSS Y/N	Yes ⁽²⁾	Yes/No ⁽²⁾
MAX SLOW SP TIME	1-30 seconds	1-250 seconds
O/C or WRONG CON protection in Inside Delta mode.	Protection active in normal set ⁽³⁾	Protection active in high set ⁽³⁾
OVERLOAD TRIP protection.	OVERLOAD TRIP will be active after Run LED is Lit. (Motor is at full voltage) ⁽⁴⁾	OVERLOAD TRIP will be active after MAX. START TIME has elapsed. ⁽⁴⁾

Notes:

- (1) Setting the INITIAL VOLTAGE to lower than 10% is not practical for loaded motors.
- (2) Refer to section 7.6.8 page 41. See PHASE LOSS protection and refer to the warning below.
- (3) Refer to section 9 page 57. See O/C or WRONG CON protection.
- (4) In order to avoid OVERLOAD TRIP in special cases (very high inertia loads), where at the end of the acceleration process, although motor is at full voltage (Run LED is Lit) and the current does not reduce to nominal, set WIDER SETTINGS to ENABLE causing the OVERLOAD TRIP to be active only after MAX. START TIME has elapsed.

WARNING!
Operator's
responsibility!

1. WIDER SETTINGS are for use in very special applications only!
Do not set WIDER SETTINGS to ENABLE unless RVS-DX is significantly larger than the motor! When using WIDER SETTINGS for the RVS-DX **you must** be extremely careful to avoid damaging the motor or RVS-DX.
2. Only cancel PHASE LOSS protection when the operator is sure that no real phase loss exists and PHASE LOSS protection is activated. This situation can occur in rare cases when there is no real fault but the RVS-DX recognizes unusual behaviour like when THDV (Total Harmonic Distortion in Voltage) in the network is high.
If this is a true case of PHASE LOSS then after cancelling PHASE LOSS protection the motor will single phase and most likely be tripped by the over load protection mechanism.

7.6.8 **Fault Parameters – page 6**

FAULT PARAMETERS _ **** _	Displays in MAXIMIZED MODE only (refer to section 7.6.3 on page 28 for changing mode)		
Display and default values	Range	Description	Remarks
PHASE LOSS Y/N YES	YES Note: Range can be extended to YES/NO by using the WIDER SETTING as described in section 7.6.7 page 39. + Special parameters ↳ Wider settings ↳ Enable	Sets PHASE LOSS trip	PHASE LOSS protection trips the RVS-DX when 1 or 2 phases are missing. Notes: If RVS-DX trips on PHASE LOSS do the following: (1) Verify that phase voltages are within the required range of the voltages. (2) If you are sure that no real phase loss exists, you can set PHASE LOSS Y/N protection to NO. This situation can occur in rare cases when there is no real fault but the RVS-DX recognizes unusual behaviour like when Total Harmonic Distortion in Voltage (THDV) in the network is high. (3) If this is a true case of PHASE LOSS then after setting PHASE LOSS Y/N protection to NO the motor will single phase and most likely be tripped by the over load protection mechanism. (4) Phase loss might not be detected in motor operating under a light load.
PHASE SEQ. Y/N NO	NO/YES	Sets PHASE SEQUENCE trip	When RVS-DX is connected “Inside-Delta”, PHASE SEQUENCE protection is always activated.
INSULATION ALARM OFF	OFF, 0.2–5Mohm	Sets INSULATION ALARM level.	Consult factory for availability.
INSULATION TRIP OFF	OFF, 0.2–5Mohm	Activates INSULATION ALARM trip.	Consult factory for availability.
AUTO RESET NO	NO/YES	Sets starter’s AUTO RESET mode of operation.	Starter can be automatically reset for UNDER VOLTAGE and PHASE LOSS faults. (Refer to section 7.6.3 on page 28 for details on adjusting UNDER VOLTAGE and PHASE LOSS faults) To start the motor after UNDER VOLTAGE and PHASE LOSS faults have disappeared, stop the START signal to terminal B1 and recommence the signal to terminal B1. AUTO RESET function has a non-programmed time delay of 60 seconds.
THERMISTOR TYPE PTC	PTC/NTC	Sets input THERMISTOR TYPE	Available only when analog card is installed.
THERMISTOR TRIP OFF	OFF, 0.1–10Kohm	Sets starter’s THERMISTOR TRIP mode of operation.	
UNDER CUR. RESET OFF	10–120min., OFF.	Sets starter’s UNDER	Starter can be automatically reset for UNDER CURRENT fault. (Refer to section 7.6.3 on

FAULT PARAMETERS - **** -	Displays in MAXIMIZED MODE only (refer to section 7.6.3 on page 28 for changing mode)		
Display and default values	Range	Description	Remarks
		CURRENT RESET time delay.	page 28 for details on adjusting UNDER CURRENT TRIP) To start the motor after UNDER CURRENT fault has disappeared, stop the START signal to terminal B1 and recommence the signal to terminal B1. A time delay (After START signal is stopped) can be programmed to activate the UNDER CURRENT RESET time.
STORE ENABLE FAULT PARAMETERS			Same as STORE ENABLE MAIN PARAMETERS on page 30.

7.6.9 I/O Programming Parameters – page 7

I/O PROGRAMMING PARAMETERS	Displays in MAXIMIZED MODE only (refer to section 7.6.3 on page 28 for changing mode)		
Display and default values	Range	Description	Remarks
PROG. INPUT C1 REMOTE RESET	START/STOP; REMOTE RESET; EXTERNAL FAULT; SLOW SPD/REVERSE; GEN. START/STOP; DUAL ADJUSTMENT;	Sets TERMINAL C1 function	Refer to section 7.6.9.1 on page 44.
FAULT RELAY TYPE FAULT	FAULT, FAULT – FAIL SAFE	Sets FAULT RELAY mode of operation.	When configured to FAULT the internal relay is energized upon fault. When configured to FAULT-FAIL SAFE the relay is de -energized upon fault. In this mode, while normal operation, the fault relay is energized. Relay will also de -energize upon control power outage.
PROG. AUX. RELAY IMMEDIATE	IMMEDIATE/ END OF ACCEL.	Sets starter's AUX. RELAY mode of operation.	When configured to IMMEDIATE – the AUX. RELAY closes its contact at start signal (after programmed “on delay” time has elapsed) and open its contact at the end of deceleration time (if any) (after programmed “off delay” time has elapsed).
RELAY ON DELAY 0 SEC.	0–60sec.	Sets starter's AUX. RELAY on delay time.	When configured to END OF ACCEL. -the AUX. RELAY closes its contact at end of soft start (after programmed “on delay” time has elapsed) and open its contact at the beginning of soft stop (if any) (after programmed “off delay” time has elapsed).
RELAY OFF DELAY 0 SEC.	0–60sec.	Sets starter's AUX. RELAY off delay time	When configured to IMMEDIATE – the AUX. RELAY closes its contact at start signal (after programmed “on delay” time has elapsed) and open its contact at the end of deceleration time (if any) (after programmed “off delay” time has elapsed).
AN. OUT PARAMETER I, 0...200% OF FLA	I, 0...200% OF FLA P, 0...200% OF Pn POWER FACTOR	Sets ANALOG OUTPUT mode of operation.	Available only when analog card is installed. When analog card is installed, full scale of the readings (20mA or 10V as per dip-switches settings) are related to 200%FLA. (2x rated motor current) or 200% of rated power or POWER FACTOR. Note: POWER FACTOR & POWER measurement only available in RVS-DX58A and up.
STORE ENABLE I/O PROG. PARAM.			Same as STORE ENABLE MAIN PARAMETERS on page 30.

7.6.9.1 PROG. INPUT C1

Terminal C1 can be programmed to operate in various modes:

TERMINAL C1 programmed function	Description
START/STOP	C1 is a maintained stop input to the RVS-DX, while B1 is a momentary start input to the RVS-DX.
REMOTE RESET	C1 is used as REMOTE RESET to reset all RVS-DX faults. The RESET command will take affect only if START command is stopped.
EXTERNAL FAULT	C1 is used as an input to the RVS-DX enabling the user to stop the motor in case of an external fault. When C1 is closed motor will stop and <i>Fault</i> LED will lit.
SLOW SPD/REVERSE	While C1 is in "ON", the motor will start slow speed forward. If C1 is moved to "OFF" (while RVS-DX still in "ON"), the motor will slow speed reverse. For adjusting the SLOW SPEED TORQUE and MAX. SLOW SPEED TIME refer to section 7.6.7 on page 39. Note: It is not possible to start the motor in "SLOW SPEED" REVERSE".
GEN. START/STOP	C1 is used to load start & stop parameters from the D. ADJ: GENERATOR PARAMETERS Page. In this mode of operation the RVS-DX will start the motor even though "WRONG CONNECTION" failure occurs. Refer to section 7.6.6 on page 38.
DUAL ADJUSTMENT	C1 is used to load start & stop parameters from the DUAL ADJUSTMENT PARAMETERS Page. Refer to section 7.6.6 on page 38.

7.6.10 **Comm. Parameters – page 8- Applicable with Optional Modbus & DeviceNet Comm.**

Note: When DeviceNet option is required an external unit, DeviceNet to Modbus Gateway is required. This gateway is connected via 2 wires to the optional Modbus terminals.

COMM.PARAMETERS - **** -	Displays in MAXIMIZED MODE only (refer to section 7.6.3 on page 28 for changing mode)	
Display and default values	Range	Description
COMM. PROTOCOL MODBUS	MODBUS	Sets RVS-DX communication PROTOCOL. Applicable when the optional communication card is installed.
BAUD RATE 9600 (MODBUS)	1200, 2400, 4800, 9600	Sets RVS-DX BAUD RATE.
PARITY CHECK EVEN	EVEN, ODD, NO – 1 STOP BITS, NO – 2 STOP BITS,	Sets RVS- DX communication PARITY CHECK.
SERIAL LINK NO. OFF	OFF,1 – 247	Sets RVS- DX communication SERIAL LINK NO. Note: If optional, external DeviceNet to Modbus Gateway is supplied set this parameter to 1.
S. LINK PAR. SAVE DISABLE	ENABLE/ DISABLE	Enables parameters modification via serial communication Note: If optional, external DeviceNet to Modbus Gateway is supplied set this parameter to ENABLE/DISABLE as required.
SER. LINK CONTROL DISABLE	ENABLE/ DISABLE	Enables start, stop, reset etc... via serial communication. Note: If optional, external DeviceNet to Modbus Gateway is supplied set this parameter to ENABLE/DISABLE as required.
MODBUS TIME OUT OFF	0.1-60 SEC., OFF	Sets MODBUS TIME OUT. If no valid Modbus communication during MODBUS TIME OUT, the HRVS-DN will trip. Trip occurs only if the following conditions exist: <ul style="list-style-type: none"> • SER. LINK CONTROL is set to ENABLE • SERIAL LINK NO. is not set to OFF If MODBUS TIME OUT is set to OFF protection is disabled.
FRONT COM ADDRES OFF	OFF,1 – 247	Future enhancement
STORE ENABLE COMM. PARAMETERS		Same as STORE ENABLE MAIN PARAMETERS on page 30. Note: After changing communication parameters and storing them, control power must be switched off and on to load new communication parameters.

7.6.11 **Comm. Parameters – page 8 - Applicable with Optional Profibus Comm.**

COMM.PARAMETERS - **** -	Displays in MAXIMIZED MODE only (refer to section 7.6.3 on page 28 for changing mode)	
Display and default values	Range	Description
COMM. PROTOCOL PROFIBUS	PROFIBUS	Sets RVS-DX communication PROTOCOL. Applicable when the optional communication card is installed.
BAUD RATE AUTO (PROFIBUS)		User can not change BAUD RATE value. Max. rate is 12 mega bit per second (MBPS).
PARITY CHECK AUTO (PROFIBUS)		User can not change PARITY CHECK settings.
PROFI. NETWORK ID OFF	OFF,1 – 126	Sets the Profibus network ID. When set to OFF the Profibus card will not function.
S. LINK PAR. SAVE DISABLE	ENABLE/ DISABLE	Enables parameter modification via serial communication
SER. LINK CONTROL DISABLE	ENABLE/ DISABLE	Enables start, stop, reset etc... via serial communication
MODBUS TIME OUT OFF	OFF	Do not change this parameter! Must be set to OFF.
FRONT COM ADDRES OFF	OFF,1 – 247	Future enhancement
STORE ENABLE COMM. PARAMETERS		Same as STORE ENABLE MAIN PARAMETERS on page 30. Note: After changing communication parameters and storing them, control power must be switched off and on to load new communication parameters.

7.6.12 **Statistical Data – page 9**

STATISTICAL DATA _ **** _		Displays in MINIMIZED MODE and MAXIMIZED MODE (refer to section 7.6.3 on page 28 for changing mode)	
Display and default values	Range	Description	
TOTAL ENERGY 0 KWH		Displays total energy drawn by the motor in KWH. Note: Reading available in RVS-DX58A and up.	
LAST STRT PERIOD NO DATA		Displays last starting time in seconds. Starting time is the duration until motor's current reaches nominal.	
LAST STRT MAX I NO DATA		Displays last starting maximum starting current.	
TOTAL RUN TIME 0 HOURS		Displays Motor's total run time.	
TOTAL # OF START 0		Displays total number of starts.	
LAST TRIP NO DATA		Displays motor's last trip cause.	
TRIP CURRENT 0 % OF FLA		Displays motor's current when motor was tripped by the RVS-DX.	
TOTAL # OF TRIPS 0		Displays total number of trips.	
PREVIOUS TRIP -2 NO DATA		Displays the motor's trip history.	
PREVIOUS TRIP -3 NO DATA			
PREVIOUS TRIP -4 NO DATA			
PREVIOUS TRIP -5 NO DATA			
PREVIOUS TRIP -6 NO DATA			
PREVIOUS TRIP -7 NO DATA			
PREVIOUS TRIP -8 NO DATA			
PREVIOUS TRIP -9 NO DATA			

7.7 **Non adjustable protection and fault Resetting**7.7.1 **Phase loss (and Under / Over Frequency)**

Becomes operational when starter is energized and protects motor from single phasing. Trips the starter when 1 or 2 phases are missing for more than 1 sec.

Starter will also trip when frequency is less than 45 or greater than 65Hz.

Note:

Phase loss might not be detected in lightly loaded motors.

7.7.2 **Phase Sequence**

Becomes operational when starter is energized, provided this protection has been activated, trips the starter when phase sequence is wrong.

Refer to section 7.6.8 on page 41 parameter PHASE SEQ. Y/N.

7.7.3 **Shorted SCR or Wrong Connections**

Becomes operational after start signal. Trips if motor is not properly connected to starter's Load terminals, when Internal disconnection in the motor winding is detected, or when one or more SCRs have been shorted.

7.7.4 **Heat-sink Over Temperature**

Thermal sensors are mounted on the Heat-sink and trip the starter when temperature rises above 85°C.

WARNING!

The over temperature protection is designed to operate under normal conditions e.g. in the event of extended low overload, insufficient ventilation – fan stoppage or air flow blockage. Incorrect starter selection, frequent starting at max. conditions, or repeated starting under fault conditions can cause SCR's overheating and failure before the heat-sink reaches 85°C to trip the thermal sensors.

7.7.5 **External Fault**

If Aux. Input contact - C1 is programmed as an External Fault (Refer to section 7.6.9.1 on page 44 for details on programming Input C1), the RVS-DX will trip if contact closes for more than 2 sec.

External Fault becomes operational when starter is energized.

7.7.6 **Fault and Reset**

When any of the protections operate, the starter locks in a fault condition, disabling thyristors firing. Fault LED lights up, fault description is displayed on the LCD and Fault Relay operates.

For local resetting, after fault has been removed, press **Reset** key.

Remote resetting can be done through Aux. Input, if programmed as REMOTE RESET. (Refer to section 7.6.9.1 on page 44 for details on programming Input C1)

When Fault occurs, followed by a voltage outage, fault condition is latched and reappears upon voltage restoration.

Note:

Resetting (Local, Remote, Serial Link or Auto Reset) is not possible as long as **Start** signal exists.

7.7.7 **Auto Reset**

UNDER VOLTAGE and PHASE LOSS, faults can be set to Auto-Reset (Refer to section 7.6.8 on page 41).

The starter will reset itself 60 seconds after voltage was fully restored provided no start signal exists.

UNDER CURRENT fault can be set to Auto-Reset (Refer to section 7.6.8 on page 41).

The starter will reset itself when a programmed time delay has elapsed provided no start signal exists.

7.8 Timing Occurrence Table

Timing And Occurrence	Active During			
	Start	Run	Stop	Soft Stop
Too many starts with Start Inhibit period	√			
Electronic Overload with Curve selection	√	√		
O/C Shear Pin (Jam)				
Starter Protection – trip immediately at 850% FLC	√	√		√
Motor Protection – trip function				
During Start – factory set at 850% FLA in less than 1 cycle (*).	√			√
During Run – adjust. 100 – 300% FLA within 1 cycle (*).		√		
Under current adjustable time delay		√		
Phase Loss	√	√		√
Phase sequence	√			
Under voltage with adjustable time delay. Time delay is override in case of “No-Volt”.	√	√		√
Over voltage with adjustable time delay	√	√		√
Long start time (Stall protection)	√			
Shorted SCR or Wrong connection	√			√
External fault – input from a N.O. contact	√	√	√	√
SCR protection by Metal Oxide Varistors (MOV)	√	√	√	√
Starter over-temperature	√	√	√	√
Starter internal test , when “On” LED is lit.	√	√	√	√
Motor Insulation test - Not Available (Consult Factory)			√	
Motor Thermistor – Not Available (Consult Factory)	√	√	√	√

8. **STARTING PROCEDURE**

Note:

It is necessary to connect a motor to load terminals otherwise S.SCR or WRONG CONNECTION Protection is activated. Other loads such as light bulbs, resistors, etc. may also cause WRONG CONNECTION Fault.

	1	When mains voltage is connected to the RVS-DX, even if control voltage is disconnected, full voltage may appear on the starter load terminals. Therefore, for isolation purposes, it is necessary to connect an isolating device before (upstream) the starter.
	2	Power factor correction capacitors or overvoltage protection devices must not be installed on starters load side. When required, install it on starter's line side.
	3	When using "Inside delta" connection, wrong connection of the starter or the motor, will seriously damage the motor; therefore make sure motor is connected properly!
	4	Do not interchange line and load connections
	5	Before starting the motor verify its rotation direction. If needed, disconnect the rotor from the mechanical load and verify the right rotation direction.
	6	Prior to Start up procedure make sure that line voltage and control voltage match the ones shown on the starter's name plate.
	7	When start signal is initiated and a motor is not connected to load terminals, the SHORT SCR or WRONG CONNECTION protection will be activated.

8.1 **Setting control voltage on-site RVS-DX8A-170A**

Control voltage can be modified on-site for models 8A to 170A. See drawings below for jumper arrangement for 115/230V control voltages.

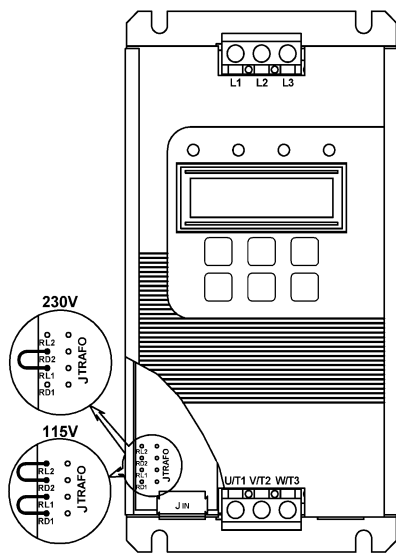

RVS-DX 8-44A

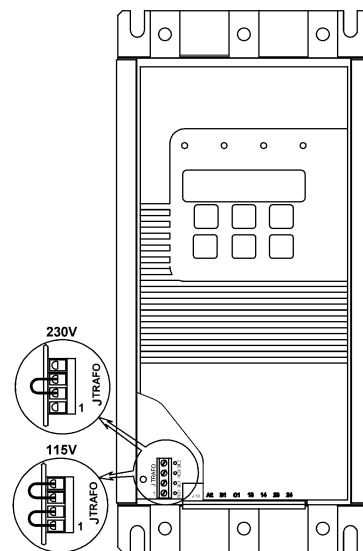

RVS-DX 58-72A

Note:

Pictures show RVS-DX8-44A & RVS-DX 58-72A.

8.2 Standard starting procedure

Connect Control Supply. On LED will lit.
 Review all parameters with Mode and Select keys Set parameters as required.
 If necessary, return to Default Parameters (see "Service Mode").
 Connect mains voltage to starter's line terminals.
 Set LCD to show "MOTOR FLA" (% of motor FLA).

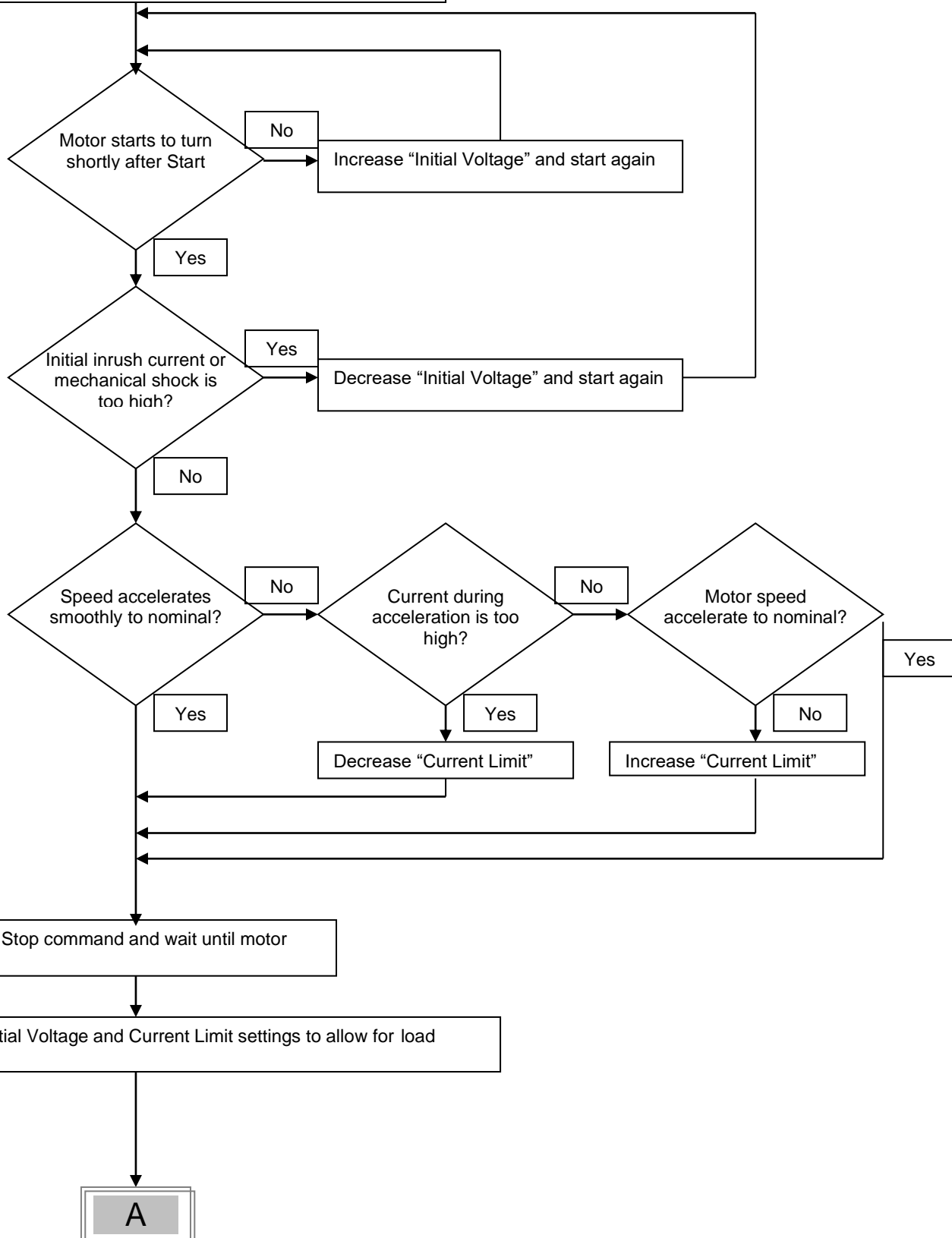

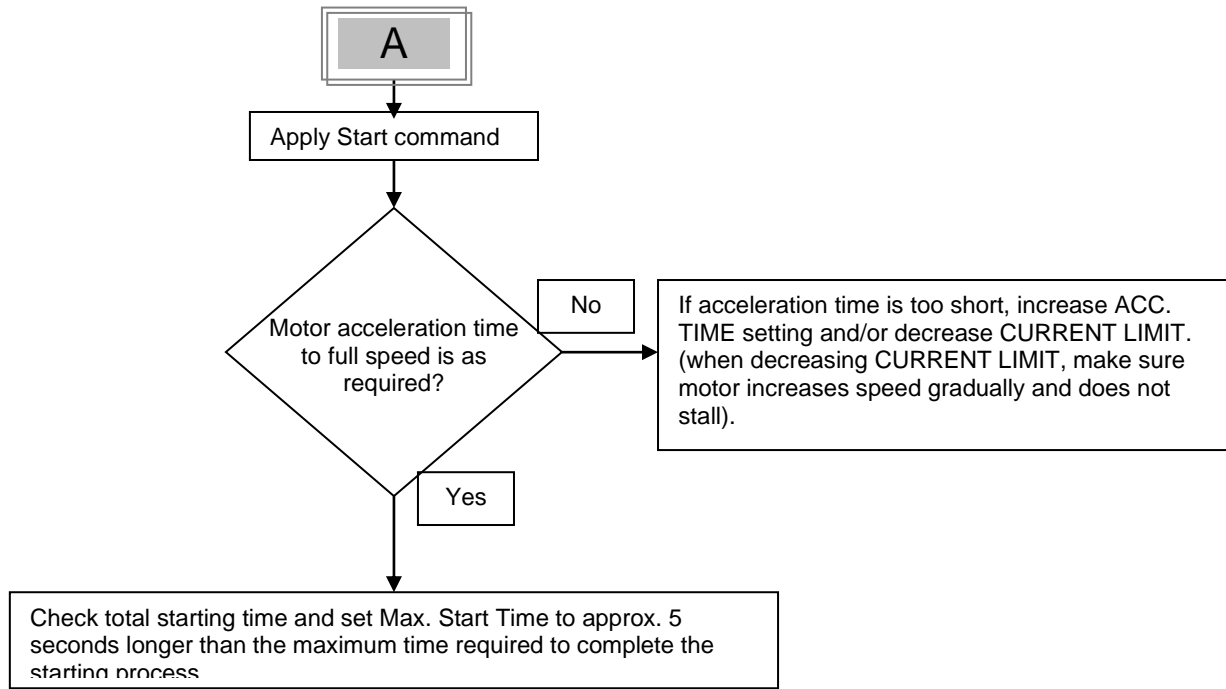

8.3 Examples of starting curves

8.3.1 Light Loads-Pumps, Fans, etc.

- INITIAL VOLTAGE – set to 30% (Factory Default)
- CURRENT LIMIT – set 300%
- ACCELERATION TIME – set 5 sec

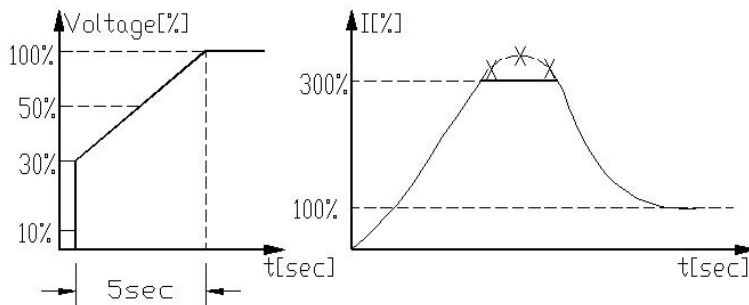

Voltage quickly increases to the INITIAL VOLTAGE value and then gradually ramps-up to nominal. Current simultaneously and smoothly increases to reach CURRENT LIMIT setting or less, before smoothly decreasing to the operating current. Motor speed will accelerate to full speed quickly and smoothly.

8.3.2 High Inertia Loads – Fans, Centrifuges, etc

- INITIAL VOLTAGE – set 50%
- CURRENT LIMIT – set 400%
- ACCELERATION TIME – set 20 sec

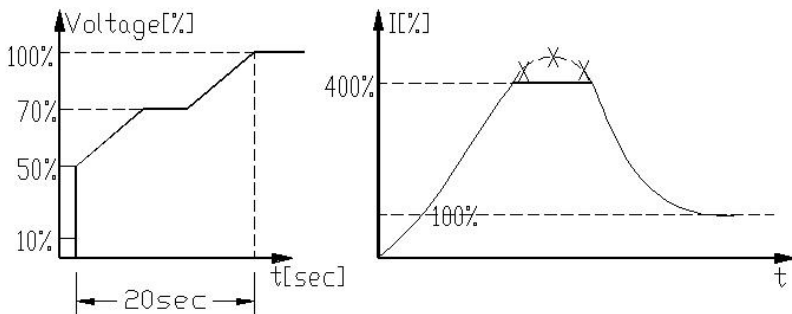

Voltage and current increase until current reaches CURRENT LIMIT. The voltage is held at this value until motor is close to nominal speed, then current will begin to decrease. The RVS-DX continues to ramp-up the voltage until reaching nominal. Motor speed smoothly accelerates to full speed.

8.3.3 Special starting – Using Dual Adjustment

For using DUAL ADJUSTMENT automatically, connect AUX. RELAY in series to Aux. Input as shown in section 8.3.3.2 on page 54.

Program PROG. AUX. RELAY to IMMEDIATE and program RELAY ON DELAY to tx.

Program PROG. INPUT C1 to DUAL ADJUSTMENT.

Program Standard parameters and DUAL ADJUSTMENT parameters as shown in the table below.

Using t_0 starting characteristics, the starter will accelerate to reach 200% current limit. After tx (PROG. AUX. RELAY DELAY) voltage to PROG. INPUT C1 is switched on, using the DUAL ADJUSTMENT characteristic to complete acceleration.

Useful to prevent initial high acceleration. (Applications: Submersible pumps, Drum fans with resonating frequency, etc).

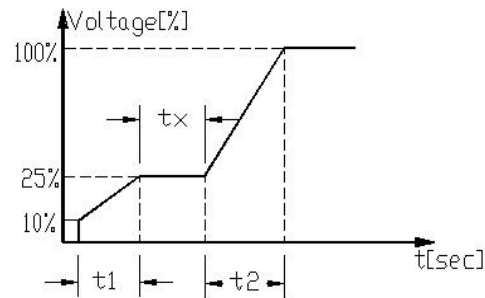

	Standard Parameter	Dual Adjustment Parameter
INITIAL VOLTAGE	10%	25%
ACCELERATION TIME	$t_1 = 2-30$ sec	$t_2 = 2-30$ sec
CURRENT LIMIT	200%	300-400%
PROG. AUX. RELAY DELAY	$t_x = 1-60$ sec.	-----

8.3.3.1 Typical wiring diagram whit line contactor

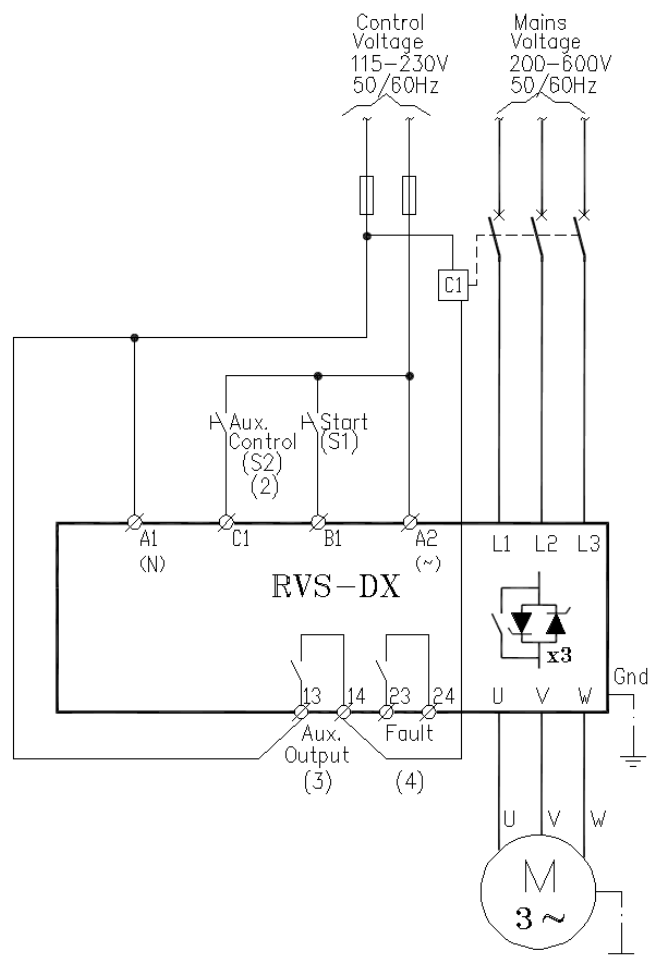

Notes:

- (1) – Circuit breaker provides IEC type 1 coordination. Use fuses for IEC type 2 coordination. Refer to section 4.3.1 on page 10
- (2) - For Aux. input programming refer to section 7.6.9 on page 43
The use of solid state relays to control the digital inputs B1 and C1 is prohibited
- (3) - For Aux. output programming refer to section 7.6.9 on page 43
- (4) - Fault relay can function as a “Fault” relay or as a “Fail-Safe” relay. For Fault relay programming refer to section 7.6.9 on page 43
- (5) - When emergency Stop switch is required it is recommended to trip a series contactor or the feeding circuit breaker. (Not shown)
- (6) – Mains voltage of 230-600V available to all models. (need to be specified)
Mains voltage of 690V only available for RVS-DX390A and up.

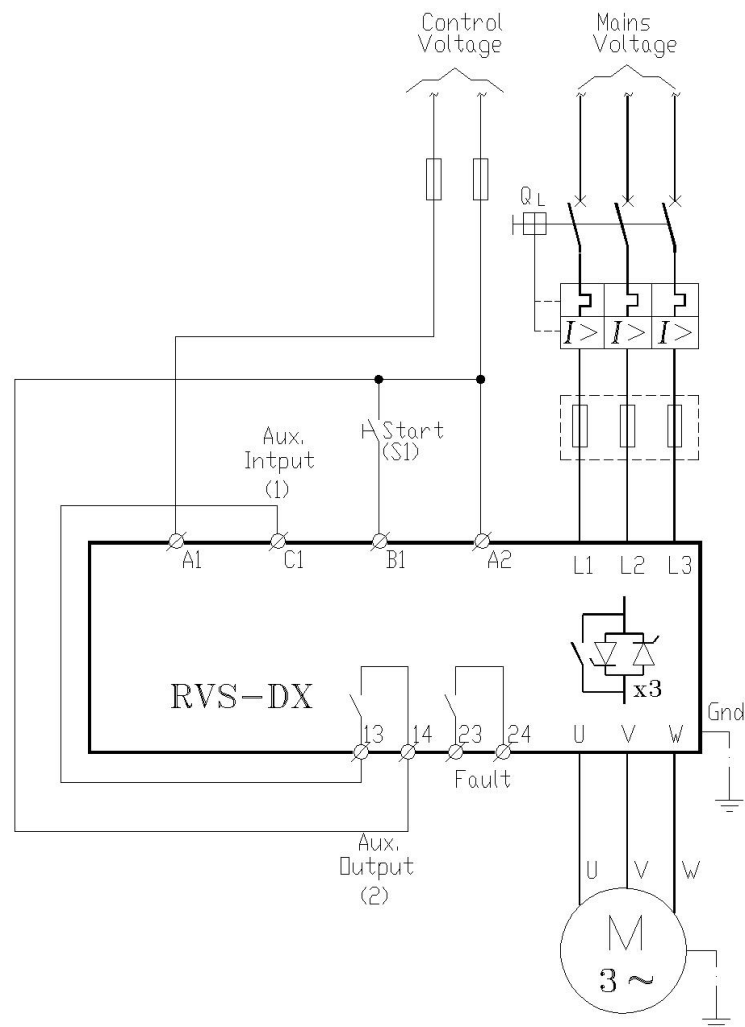
8.3.3.2 Special starting – Using Dual Adjustment – wiring scheme**Notes:**

- (1) - Program PROG. INPUT C1 to DUAL ADJUST
- (2) - Program PROG. AUX. RELAY to IMMEDIATE and program RELAY ON DELAY to tx. Refer to section 7.6.9 on page 43 for details on I/O programming.

8.3.4 **Choosing a suitable Pump Curve (centrifugal Pumps)**8.3.4.1 Starting Curve

- Adjust MAIN PARAMETERS as necessary (FLA, FLC, etc..)

- Set STARTING CURVE, ACCELERATION TIME, CURRENT LIMIT, and INITIAL VOLTAGE to their default values (curve 0, 10 sec., 400% and 30% respectively).
- Start the pump while watching the pressure gauge as the pump starts and look for overshooting (“Pressure Surge”) of the gauge needle above the target pressure. In case of over pressure, choose a peak torque reduction curve (Pump Control curve 1!).
- Set START CURVE 1!, increase ACCELERATION TIME to 15 seconds and reduce CURRENT LIMIT to 350%. Start the pump and watch the pressure gauge while the pump starts.
- In most cases, overshooting is reduced. If the overshoot persists, increase ACCELERATION TIME to 25 seconds (confirm with motor manufacturer) and try again.
- If the overpressure persists, increase START CURVE setting to 2!, or 3!, if necessary. Each increase in START CURVE setting will reduce the Peak Torque, thus, reducing the overpressure and preventing the “Pressure Surge” during start.
- To increase starting time above these maximums, employ “Special Starting” for these techniques (Consult factory).

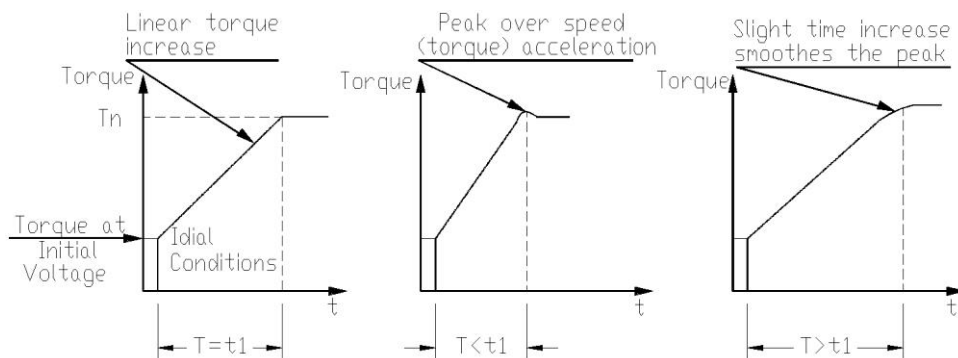

8.3.4.2 Stopping Curve

- Adjust MAIN PARAMETERS as necessary (FLA, FLC, etc..)
- Set STOP CURVE and DECELERATION TIME, to their default values (curve 0, 10 sec., respectively).
- Stop the pump, watching the pressure gauge and check valve as the pump stops. Look for overshooting (“Water Hammer”) of the gauge (abruptly stops the pump and the motor).
- Select STOP CURVE 1, increase DECELERATION TIME to 15 seconds. Stop the pump and watch the pressure gauge and the rate of closing of the check valve as the pump stops. Abrupt stopping of the pump and motor will cause a loud audible noise emitted from the check valve.
- In most cases, “Water Hammer” is reduced. If the “Water Hammer” persists, increase the time to 25 seconds (confirm with motor manufacturer) and try again.
- If the “Water Hammer” persists, increase STOP CURVE setting to 2!, or 3!. Each increase in STOP CURVE will reduce the abrupt stop of the pump, thus, preventing the “Water Hammer” phenomenon.

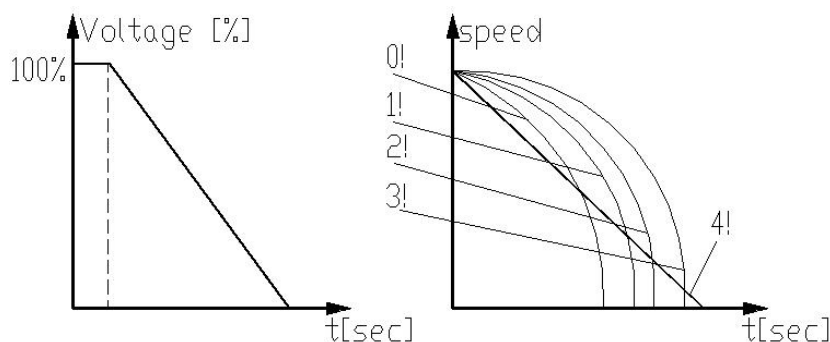

8.3.4.3 Final torque during soft-stopping a pump motor

While decelerating, the check valve may close before DECELERATION TIME has elapsed, thus, allowing current to flow through stator winding causing unnecessary heat. Select FINAL TORQUE sensitivity to 1, and stop the pump, confirm that current stopped flowing through the motor shortly after the check valve closed. If current still flows more than 3-5 seconds after check valve closure, increase FINAL TORQUE up to 10 if necessary, to stop current flow earlier

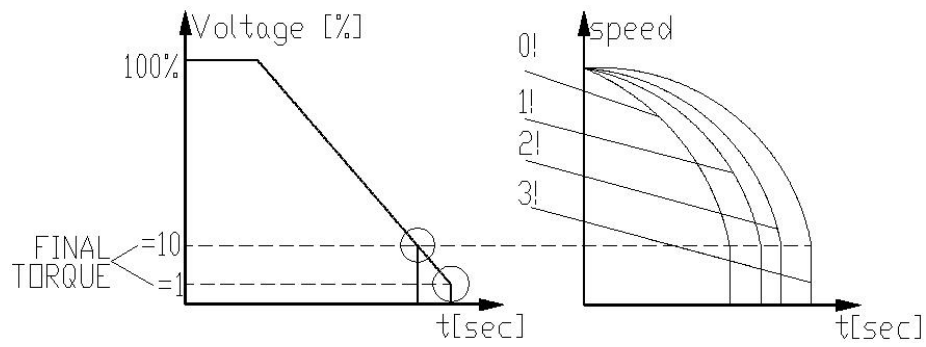

9. TROUBLE SHOOTING

Upon fault – motor stops, *Fault* LED lights and Fault Relay operates. The LCD shows TRIP: and fault description. (for example: TRIP: UNDER CURRENT).

Fault Message	Cause and trouble shooting
TOO MANY STARTS	<p>Trips the starter if number of starts, during START PERIOD exceeds the preset number.</p> <p><i>Wait until motor and starter cool down – according to START INHIBIT setting. For more information on adjusting START PERIOD and START INHIBIT refer to section 7.6.4 on page 32.</i></p>
LONG START TIME	<p>Trips the starter if output voltage does not reach nominal at the present MAX. START TIME.</p> <p><i>Check FLA, FLC, and MAX START TIME settings. Increase INITIAL VOLTAGE, CURRENT LIMIT & MAX. START TIME or decrease ACCELERATION TIME as necessary. For more information on FLC & FLA refer to section 7.6.3 on page 28 (MAIN PARAMETERS). For more information on adjusting START PARAMATERS refer to section 7.6.4 on page 32.</i></p>
O/C – SHEAR PIN	<p>Trips the starter when: Instantaneously when current exceeds 8.5 x Starter FLC. (not programmable) During starting when current exceed 8.5 x Motor FLA. (not programmable) During running when current exceeds 100-300%. (programmable value) O/C Shear-Pin has a programmable delay of 0-5 seconds where the starter detects the fault and does not trip before time delay has elapsed (delay is override when current reaches 8.5 x Starter FLC).</p> <p><i>Check that motor is not installed or Jammed. Check FLA, FLC settings. Check motor and cable connections. Perform a “Megger” test to verify motor and cable’s condition. For more information on FLC,FLA & O/C – SHEAR PIN refer to section 7.6.3 on page 28 (MAIN PARAMETERS).</i></p> <div data-bbox="944 1160 1487 1489" style="border: 2px solid black; padding: 5px;"> <p>CAUTION Check that “Meger” maximum voltage is no more than 500V !!</p> </div>
O/C or WRONG CON.	<p>Trips the soft RVS-DX when connected Inside Delta and Wrong connection or if over current is detected by the RVS-DX.</p> <p><i>Verify that the motor is not stalled or shorted and check cables and wiring. Verify that motor and RVS-DX are connected exactly as shown in section 4.3.9.2 page 13. If circuitry is 100% confirmed it is possible to start when WIDER SETTINGS are ENABLED. Refer to section 7.6.7 page 39. If a fault occurs again consult the factory. The operator is advised to try operating one time only. Note that it is useless to try starting in this mode more than once.</i></p>
OVERLOAD	<p>Trips the starter when current exceed the OVERLOAD TRIP level and thermal register has filled up.</p> <p><i>Check FLA, FLC and Overload settings, check motor current, wait 15 minutes to let motor and starter cool down before restarting. For more information on FLC, FLA & OVERLOAD settings refer to section 7.6.3 on page 28 (MAIN PARAMETERS).</i></p>

Fault Message	Cause and trouble shooting
UNDER CURRENT	<p>Trips the starter when line current drops below the preset level for the preset time.</p> <p><i>Check UNDER CURRENT TRIP and TIME DELAY settings, check line currents through L1, L2, L3.</i></p> <p><i>For more information on UNDER CURRENT settings refer to section 7.6.3 on page 28 (MAIN PARAMETERS).</i></p>
UNDER/NO VOLTAGE	<p>Trips the starter when line voltage drops below the preset level for the preset time.</p> <p><i>Check UNDER VOLTAGE TRIP and TIME DELAY settings, check line voltages on L1, L2, L3. When voltage drops to zero, the starter trips immediately with no delay.</i></p> <p><i>For more information on UNDER VOLTAGE settings refer to section 7.6.3 on page 28 (MAIN PARAMETERS).</i></p>
OVER VOLTAGE	<p>Trips the starter when line voltage increases above a preset level for a preset time.</p> <p><i>Check OVER VOLTAGE TRIP and TIME DELAY settings, check line voltage on L1, L2, L3.</i></p> <p><i>For more information on OVER VOLTAGE settings refer to section 7.6.3 on page 28 (MAIN PARAMETERS).</i></p>
PHASE LOSS	<p>Trips the starter if 1 or 2 phases are missing.</p> <ul style="list-style-type: none"> • <i>Check voltages are within the required range voltages and frequency is within the range of 45-65Hz.</i> • <i>If all previous actions are do not solve the problem and the you are sure that no real phase loss exists, you can set PHASE LOSS Y/N protection to NO. This situation can occur in rare cases when there is no real fault but the RVS-DX recognizes unusual behaviour like when Total Harmonic Distortion in Voltage (THDV) in the network is high.</i> • <i>If this is a true case of PHASE LOSS then after setting PHASE LOSS Y/N protection to NO the motor will single phase and most likely be tripped by the over load protection mechanism.</i> • <i>Phase loss might not be detected in motor operating under a light load.</i> <p><i>For PHASE LOSS protection setting refer to section 7.6.8 page 41.</i></p>
PHASE SEQUENCE	<p>Trips the starter if line phase sequence is wrong.</p> <p><i>Check line phase sequence, and if wrong, swap two wires on line side. If motor now rotates in the wrong direction, swap two wires on load side.</i></p>
S. SCR OR WR. CONNECTION	<p>Trips the starter when one or more motor phases are not properly connected to starter's load terminals, in case of internal disconnection in motor winding or if any SCR is short-circuited or when motor windings are shorted.</p> <p><i>Check with an ohmmeter between L1-U, L2-V, L3-W; resistance > 20 KΩ.</i></p> <p><i>Check for no voltage on terminals U, V, W (from parallel system or an independent by-pass). SCRs may fail due to:</i></p> <ul style="list-style-type: none"> ▪ <i>High short current not protected by proper fuses</i> ▪ <i>High voltage spikes not protected by proper external Varistors.</i> ▪ <i>Frequent starting at maximum conditions or fault conditions.</i> <p><i>If required, may be eliminated by using generator mode (programming AUX. IN PROG INPUT parameters accordingly)</i></p> <p><i>For more information on programming AUX. IN PROG INPUT refer to section 7.6.9 on page 43(I/O PROGRAMMING PARAMETERS).</i></p> <p>Note:</p> <p><i>Shorted SCR and Wrong Connection faults are not active in Generator mode.</i></p>

Fault Message	Cause and trouble shooting
OVER TEMPERATURE	<p>Heat-sink over-temperature. Trips the starter when heat-sink temp. rises above 85°C.</p> <p><i>Check that motor starting is not too frequent.</i></p>
EXTERNAL FAULT In MAXIMIZED display Mode	<p>Trips the starter when a N.O contact between Aux. input terminals 13, 14 closes for over two seconds.</p> <p><i>Check contact position and cause of closure.</i> <i>For more information on programming AUX. IN PROG INPUT refer to section 7.6.9 on page 43(I/O PROGRAMMING PARAMETERS).</i></p>
SLOW SPEED TIME	<p>Slow speed time is exceeded.</p> <p><i>Check the settings of MAX SLOW SP TIME.</i> <i>For more information on programming MAX SLOW SP TIME refer to section 7.6.7 on page 39 (SPECIAL FEATURES PARAMETERS).</i></p> <p>Note: <i>Motor and RVS-DX may be overheated when operating at slow speed for an extended period.</i></p>
WRONG PARAMETERS	<p>Parameters not transferred from RAM to EEPROM or vice versa. After replacing the EPROM with a new software version or after power up.</p> <p><i>Press MODE and ▼ simultaneously, than press STORE and MODE simultaneously. By doing that, you are loading factory defaults to the RVS-DX. Now program all parameters into the RVS-DX like in a first start-up procedure.</i></p> <p><i>(If Fault LED is on, press Reset after WRONG PARAMETERS).</i></p>
MODBUS TIME OUT	<p>If no valid Modbus communication during MODBUS TIME OUT, the HRVS-DN will trip.</p> <p>Trip occurs only if the following conditions exist:</p> <ul style="list-style-type: none"> • SER. LINK CONTROL is set to ENABLE • SERIAL LINK NO. is not set to OFF <p><i>For MODBUS TIME OUT settings refer to section 7.6.10 page 45.</i></p>
COMM. PORT FAILED	<p>Trips the RVS-DX if, when controlled via Profibus communication link, the communication cable is torn or the communication from the PLC is lost.</p> <p>Note that the occurrence of this fault depends on then “Watch Dog” function of the Profibus controller.</p> <p><i>You must reconnect the wiring and/or the communication with the PLC and wait for a start command initiated by the PLC.</i></p>
FREQUENCY	<p>Trips the soft starter when mains voltage frequency is not within the limits of 45-65Hz.</p> <p><i>Check mains frequency.</i></p>

9.1 Blank RMA Form

Return Material Authorization Form-"RMA" - Fault Report – Non/ Warranty Claim

After Sales Service Department

E-mail: tech.support@solcon.com Tel. + 972 – 77-7711130, 972-77-7711137 Fax. + 972 – 77-7711140**To be completed By Solcon Service Dept.:**

Return Material Authorization Number	
Date	
Authorized by	

Equipment Model:			
Equipment Serial no.:			
Report date			
Date of equipment sale		Date of installation	
Representing Firm			
Contact person			
Telephone number		Fax number	
Email address			
Application			
Starter Rating			
Motor current rating (motor Label)			
Number of starts per hour			
Special installation / ambient factors (°C)			
Type of Fault Reported & time of occurrence (during start, after start, during soft stop, end of soft stop, ON B.P. closing, when ...			
Last Start Period		Total Number Of Trips	
Last Start Max. I		Starter FLC	
Total Run Time		Motor FLC	
Total Number Of Starts		Initial Voltage	
Last Trip		Acceleration Time	
Trip Current		Current Limit	
Remarks			
By Distributor: We declare that product has been correctly applied, installed and operated, in accordance with Solcon's written instructions, appropriate codes, regulations and good practice, within the limits of rated capacity and normal usage.	Warranted repair/replacement		

10. TECHNICAL SPECIFICATIONS:

Supply Voltage	Line to Line 230-600V (to be specified) + 10%-15% for all models Line to Line 690V (to be specified) + 10%-15% for RVS-DX 390A and up
Frequency	45 – 65 Hz (Fixed or variable frequency source)
Control Supply	115V or 230V (to be specified) +10% - 15%
Load	Three phases, three wires, squirrel cage induction motor.

Start-Stop Parameters:

Starter FLC	Starter's Full Load Current, according to Selector Guide
Motor FLA	Motor Full Load Ampere 50-100% of Starter FLC (Full Load Current).
Pump and Torque Control Curves	Field selectable curves preventing Over-pressure during start and Water Hammer during stop.
Pulse Start Duration	A pulse of 80% Un, adjustable range 0.1-1 Sec, for starting high friction loads.
Initial Voltage,	5-80% Un
Initial Current	100-400% of Motor FLA
Current Limit	100-500% of Motor FLA
Acceleration Time	1-90 Sec
Deceleration Time	1-90 Sec

Motor Protection:

Too Many Starts	Maximum number of starts, range: Off or 1-10, during a time period 1-60 min.
Starts inhibit	Period of 1-60 min, during which starting is prevented, after Too Many Start fault.
Long Start Time (Stall protection)	Maximum allowable starting time 1-30 sec. (1-250sec. in WIDER SETTINGS)
Over Current (Shear-pin)	Two operation functions: during starting trips the starter at 850% and during running at 100-850% In, both within 1 Cycle (after internal delay).
Electronic Overload (I ² t)	Adjustable IEC and MEMA curves.
Under Current	Trips when current drops below 20-90% In, time delay 1-40 sec.
Under Voltage*	Trips when main voltage drops below 50-90%, time delay 1-10 Sec
Over Voltage	Trips when main voltage increase above 110-125%, time delay 1-10 sec.
Phase Loss, Under/Over Frequency*	Trips when one or two phases are missing and frequency is 45Hz. or 65Hz.
Phase Sequence	Trips when phase sequence is wrong
Shorted SCR or Wrong connection	Prevents starting, trips if motor is not connected / incorrectly connected to the starter, or in case one or more SCRs have been shorted
Heat Sink Over temp	Trips when heat-sink temperature rises above 85°C.
External fault	Trips when an External Contact closes for 2 sec.
* With optional Auto Reset.	

Control:

Displays	LCD in 4 – Field selectable languages and 4 LEDs.
Keypad	6 keys for easy setting
Fault Contact	2 Contacts, 8A, 250VAC, 2000VA
Aux. Contact – Imm. or End Of Acc.	2 Contacts, 8A, 250VAC, 2000VA

Temperatures:

Operating -10° to 40°C
Storage -20° to 70°C

Standards:

Dielectric Test	2500VAC
Degree of Protection	IP 20 for frame size D1, IP 00 for frame sizes D2-D5
EMC Emissions	EN 55011 CISPR 11 Class A
Immunity	EN 55082-2 ESD 8KV air, IEC 801-2 Electric RF field 10 V/m, 20-1000MHz, IEC 801-3 Fast transients 2KV, IEC 801-4
Safety	EN 600947-1 Related to safety requirements. Designed and assembled to conform with UL508C

Normal Service Conditions:

Altitude

Up to 1000m. For equipment to be used at higher altitudes consult Factory.

Humidity

95% at 50°C or 98% at 45°C.

Control Power Consumption

The approx. consumption of RVS-DX soft starters is as follows:

Model	Before bypass Closed	Inrush During bypass closing	After bypass closed
8	20VA	20VA	20VA
17	20VA	20VA	20VA
31	20VA	20VA	20VA
44	20VA	20VA	20VA
58	20VA	20VA	20VA
72	20VA	20VA	20VA
85	20VA	20VA	20VA
105	20VA	20VA	20VA
145	20VA	20VA	20VA
170	20VA	20VA	20VA
210	20VA	30VA	30VA
310	20VA	30VA	30VA
390	20VA	600VA	40VA
460	20VA	800VA	40VA
580	20VA	1700VA	40VA
820	20VA	1700VA	40VA
950	20VA	2400VA	60VA
1100	20VA	2400VA	60VA

1. CONSTRUCTION DETAILS:

The product shall be constructed in accordance with the following description.

Spacings - Spacings were evaluated and found to be in accordance with UL 508, Seventeenth Edition and UL 840, Second Edition.

Tolerances - Unless specified otherwise, all indicated dimensions are nominal.

Marking - Ink-stamped label or die-stamped on metal plate permanently secured to the enclosure, designated Listee's name, model number and electrical ratings.

Surrounding Air Temperature Rating 60°C Maximum 8-170A units;

Short Circuit Current Rating for Frame Sizes 2, 3 and 4 devices
Suitable For Use On A Circuit Capable Of Delivering Not More Than 10,000 rms Symmetrical Amperes, 600 Volts Maximum When Protected By A Circuit Breaker Having an Interrupting Rating Not Less Than 10,000 rms Symmetrical Amperes, 600 Volts Maximum.

2. INSTALLATION INSTRUCTIONS:

Each reduced voltage motor starter shall be supplied with installation instructions which specifies:

1. Input power and output motor field wiring shall be copper conductors only, rated 60°C or 75°C.
2. This device is to be mounted in a suitable enclosure, and spaced 1/4 in. minimum from enclosure surface.
3. Lug kit for High Available short circuit ratings.

Type	FLA(A)	Wire used	Torque (in-lb)	Lug catalog #	Alternate catalog #	Remarks
RVS-DX	58	# 6 to 2/0	125	10055232G1 with a terminal link 270A8125	SSXABPD301	UL Lug. Ref E9570 Vol W Sec 68
RVS-DX	72					
RVS-DX	85					
RVS-DX	105					
RVS-DX	145	# 6 to 250MCM	200	10055233G1 with a terminal link 270A8123	SSXABPD401	UL Lug. Ref E9570 Vol W Sec 68
RVS-DX	170					

Alternate lugs : Any UL listed lugs suitable to carry the required current can be used as alternate to the above given lugs.

Alternate Cat. Nos. – The manufacturer may assign alternate Cat Nos. that includes the hardware to mount the lugs as follows: Cat no. SSXABP followed by D2,D3,D4,D7 & D8 followed by 01 to 99 with or without additional suffix numbers and letters.

